

Department of E&TC

BSNL RTTC VISIT REPORT

An industrial visit was organized for students of BE E&TC on **24/01/2020 to 25/01/2020**. One theory session (on introductory basics of GSM-architecture, Mobility management & Call PROCESSING overview) and the industrial visit to GMSC (Mobile switching unit) at Chinchwad. The theory session was conducted at RTTC BSNL Chinchwad at 11.00 am by Mr. Gulhane and after that Visit was conducted at GMSC Chinchwad at 14.00 hrs. Total 131 students of BE1 and BE2 were present for visit.

The venue for the theory session:- Regional telecom training centre Plot No 121/122 G Block, MIDC in front of hotel Bhole, near KSB Chowk , Nigdi Bhosari road, Chinchwad, PUNE-19

The venue for the visit :- GMSC, Chinchwad Telephone Exchange near Niramay Hospital & Chinchwad station Post office, Chinchwad station, Chinchwad pune -19.

The BSNL course coordinator for the visit was Shri D.S. Borole -9422327101

The topics covered in the 120 minute lecture included:

- 1 Overview of Mobile Communication
- 2 GSM Principles
- 3 GSM Network Architecture
- 4 GSM Upgradation
- 5 3G-UMTS
- 6 LTE Architecture
- 7 Future-what's next
- 8 5G Technology

After the lunch session we were taken to the exchange center where the components required for mobile communication were shown to the students. The officials there showed the structures of BTS, MSC's and how the connections are established using the routers available in the exchange. The officials there also stated the importance of the BTS and BSC's, MSC's for mobile communication and how care should be taken effectively for that. The visit was then concluded at nearly 4:30 p.m.

Prof. U. V. Bomble and Prof. M. M. Dhanvijay were the staff representative present.

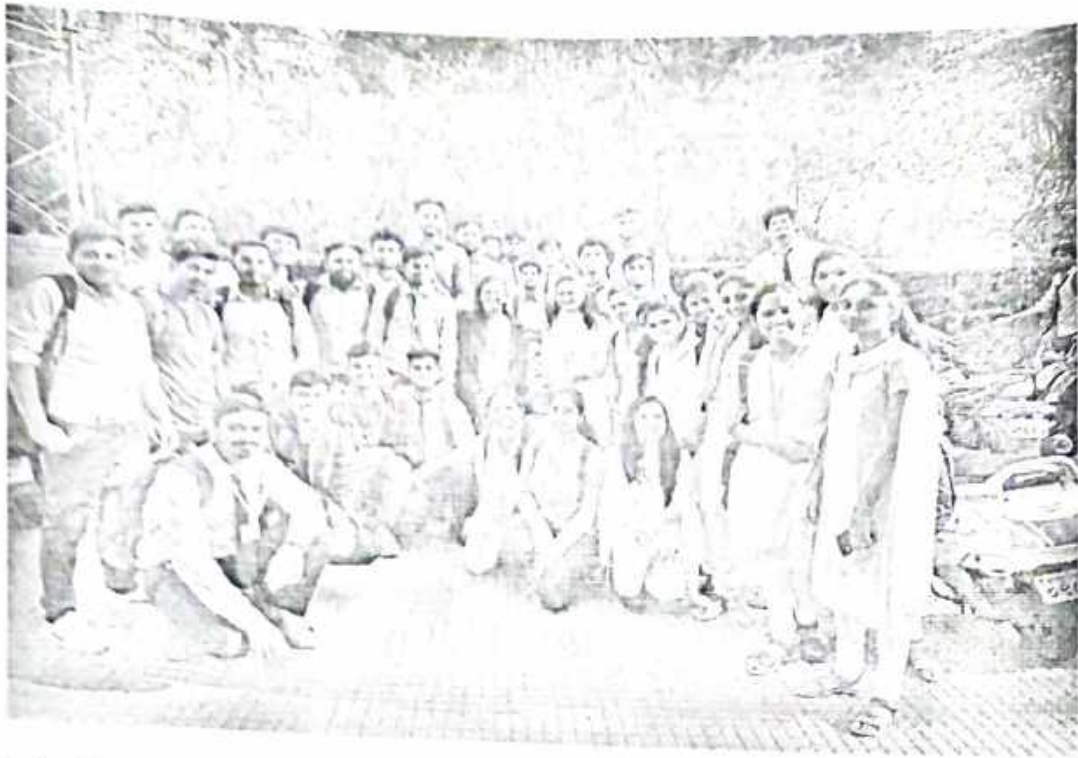

Day 1. 24/01/2020

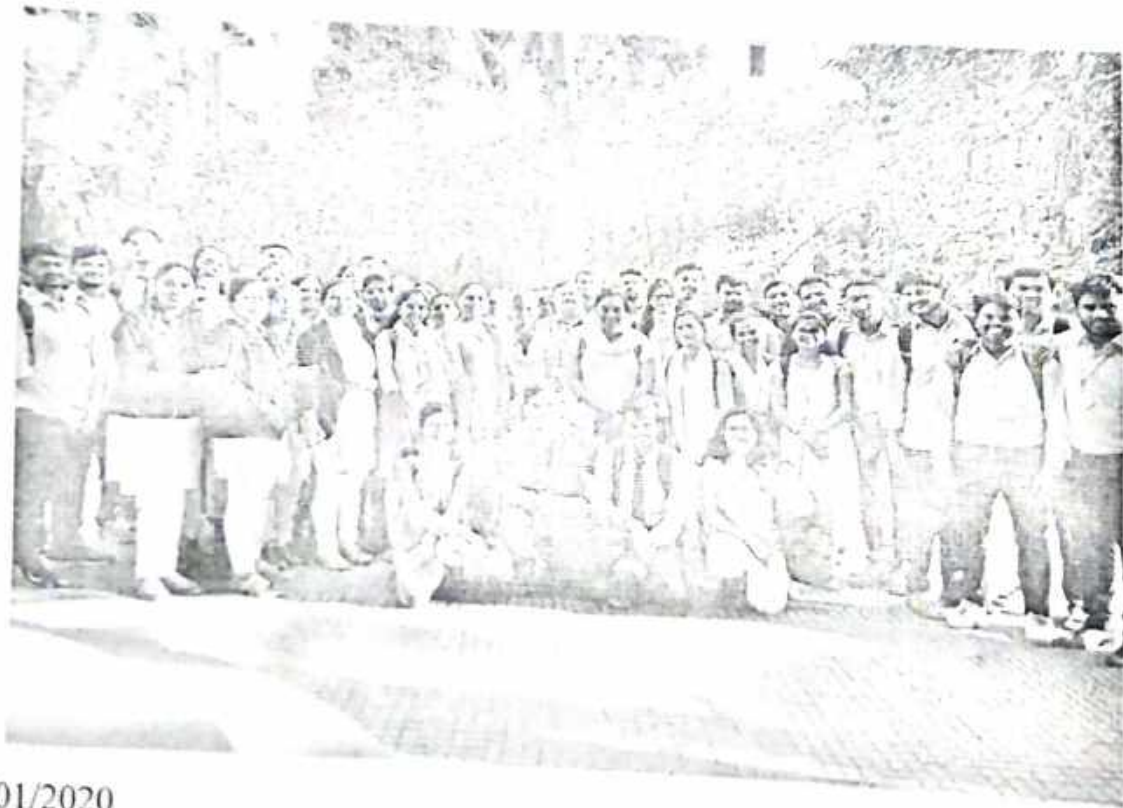

Day 2. 25/01/2020

Visit at MSO, Chinchwad, Pune

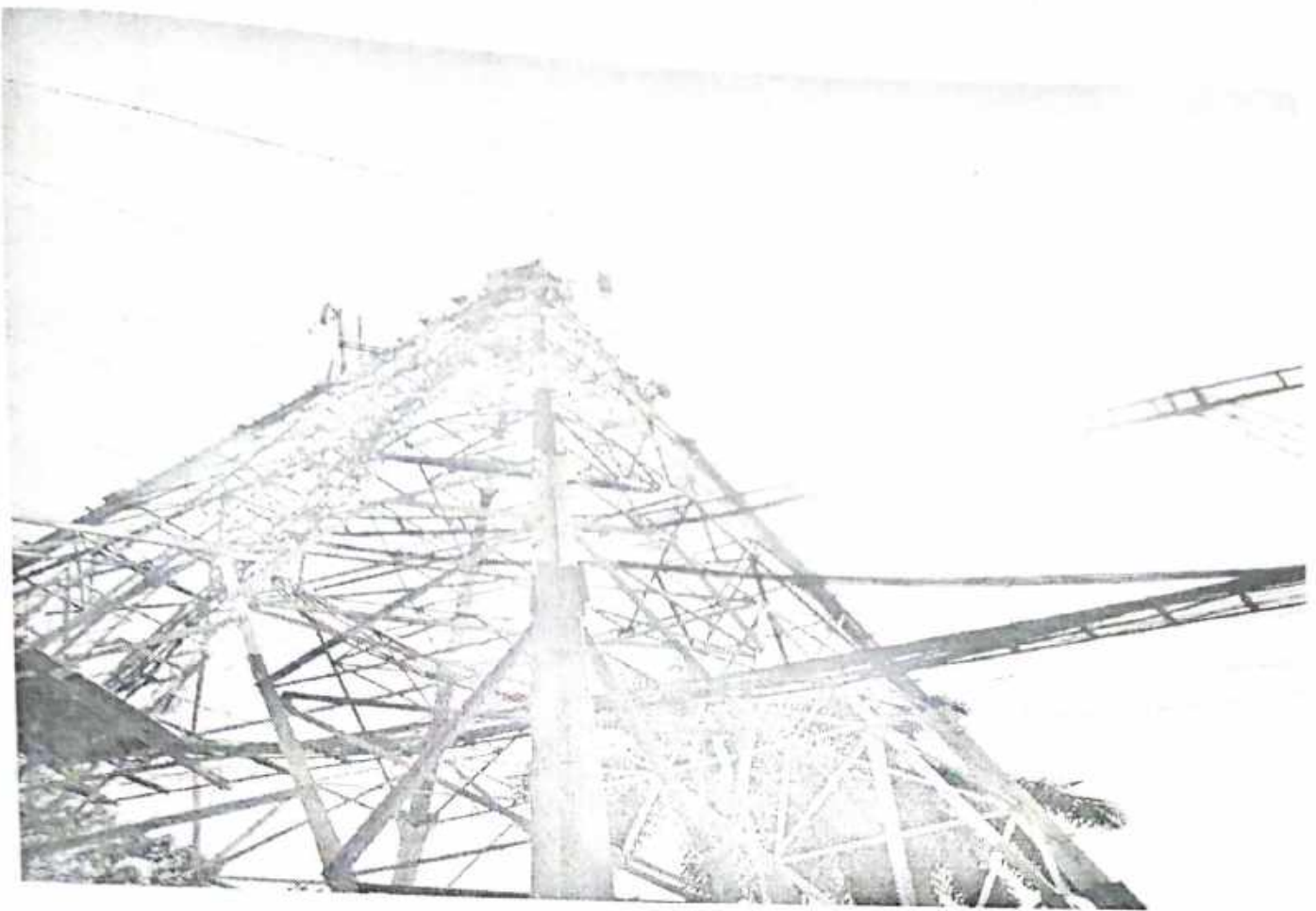

Visit at MTSO, Chinchwad, Pune

Prof. U. V. Bomble

Prof. M. M. Dhanvijay
Subject Teachers

Prof. A. A. Dhavlikar

Prof. M. M. Dhanvijay
Visit Coordinators

Prof. P B Chopade
HOD



MES College of Engineering, PUNE-411001
Department of Mechanical Engineering

Ref No.

Date : **Monday 24/09/2018**

Activity : **Industrial Visit**

Name of Activity: **Industrial visit to BAKER GAUGE IND PVT LTD.**

Objectives of Activity: To prepare students for

- 1 Students will be able to see the precision measuring instruments manufacturing
- 2 Students will be able to understand the thread metrology and manufacturing of thread gauges
- 3 Students will be able to see the working of CMM
- 4 Students will be able to get knowledge of different quality aspect in industry

Target group: TE Mechanical

Number of Present Students: 110

Total Number of targeted group of Students: 134

Resource Person Details

Name of Resource Person: Mr. Taizoon Baker/ Mr. VENKITRAMAN
Designation: MD/Dy. Gen. Mgr. (HR & ADMIN)
Organisation / institute: Baker Gauges India Private Limited, Pune

Activity Schedule

Duration : 18/09/2018 to 18/09/2018
Time : 07:45 AM
Venue: 1) Baker Gauges India Private Limited (BMI Division)
33-1-2, Nagar Road,
Pune-411014. India.
2)
33-1-2, Nagar Road,
Pune-411014. India.
Phone : 91-20-66093800
Fax : 91-20-66093888
Email : bakerbmi@bakergauges.com
Baker Gauges India Private Limited (HIP Division)
37-40, Viman Nagar,
Off Nagar Road,
Pune-411014. India.

Activity Organised by: Mr. K. A. Mahajan

Faculty Associated : Mr. P. S. Pandure

Brief Description of Activity:



MES College of Engineering, PUNE-411001
Department of Mechanical Engineering

TE A reported to HIP division on 7.45 am and TE B reported to BMI Division on 7.45 am. In HIP and BMI Division first Corporat VCD presentation were presented and then company visit was conducted. After the visit at 10.30 both the classes were exchanged and reported at 10.45 to HIP and BMI Divisions respectively.



MES College of Engineering, PUNE-411001
Department of Mechanical Engineering

Activity Photographs





MES College of Engineering, PUNE-411001
Department of Mechanical Engineering

Attendance Certificate



MES College of Engineering, PUNE-411001
Department of Mechanical Engineering

ATTENDANCE CERTIFICATE

This is to certify that TE Mechanical students from MES College of engineering Pune-411001, have Successfully participated in Industrial visit to BAKER GAUGE IND PVT LTD.

Activity Details:

Date : Tuesday 18/09/2018 to 18/09/2018
Time : 07:45 AM
Venue : BAKER GAUGE IND PVT LTD, VIMAN NAGAR, NAGAR ROAD, PUNE
Total number of students participated : $\left. \begin{array}{l} TE - A = 51 \\ TE - B = 59 \end{array} \right\} \text{Total} = 110$
Activity Organised by : Mr. K. A. Mahajan

Resource Person Details

Name of Resource Person : Tejzoon Baker | M. R. VENKITARAMAN
Designation : MD
Organisation / institute: : BAKER GAUGE IND PVT LTD
Mobile number : 9823353215
Email ID : venkat@bakergauge.com

For BAKER GAUGE INDIA PVT. LTD.
(HIP DIVN.)

M. R. VENKITARAMAN
Dy. Gen. Mgr. (HR & ADMIN)

Resource Person
BAKER GAUGE IND PVT LTD

Seal:





MES College of Engineering, PUNE-411001
Department of Mechanical Engineering

Activity to PO linking: 1: Slight (Low), 2: Moderate (Medium), 3: Substantial (High)

PO1	PO2	PO3	PO4	PO5	PO6	PO7	PO8	PO9	PO10	PO11	PO12	PO13	PO14	PO15
3	2	1	2	3	1	1	1	2	3	1	3	3	3	1

Activity to PO Linking Justification

PO No	Level (1,2,3)	Justification For Activity to PO Linking in Level (1,2,3)
PO1	3	1) Engineering. specialization and fundamentals to the solution of complex engineering/ measuring problems.
PO2	2	2) Substantiated conclusion using 1st principles of mathematics
PO3	1	Appropriate consideration of public health and safety societal and environmental consideration.
PO4	2	Implementation of data, analysis and synthesis of information.
PO5	3	Modern tool used including prediction and modeling to complex engineering activities.
PO6	1	Professional Engineering practice about safety health and societal responsibilities.
PO7	1	7) Susubtatble development through professional engineering solution.
PO8	1	Professional ethics and responsibilities of the engineering practices.
PO9	2	Function effectively as a member of diverse team.
PO10	3	Comprehend and effective visit report.
PO11	1	Knowledge of engineering and management principles.
PO12	3	Lifelong learning in broadest context of technical change.
PO13	3	Use of principles of measurement, machine design, manufacturing, thermal and management to solve real life tools.
PO14	3	Modern modeling simulation and computational tools.
PO15	1	Practical solution of mechanical problem.

Mr. K. A. Mahajan
 Activity Organiser

HoD
 Mechanical Engg. Dept.



MES College of Engineering, PUNE-411001
Department of Mechanical Engineering

ATTENDANCE REPORT

MES College of Engineering, PUNE-411001
Department of Mechanical Engineering

ATTENDANCE REPORT Date: 18/09/2018
 Name of Activity : Industrial visit to BAKER GAUGE IND PVT LTD

Roll No	PRN	Class	Name of Student	Signature
42	F16312025	TE-B	Bingdar Tukarao Shrishkail	<i>[Signature]</i>
03	F16312003	TE-B	Bhujbal natesh, Dinesh	<i>[Signature]</i>
21	F16312002	TE-B	Mayur chaudhan	<i>[Signature]</i>
09	F16312009	TE-B	Vinay P. Hoshing.	<i>[Signature]</i>
68	F17322003	TE-B	Ketan. Ajgaonkar	<i>[Signature]</i>
78	F17322014	TE B	pathan Suhel	<i>[Signature]</i>
67	F17322002	TEB	Hajave Pritish	<i>[Signature]</i>
76	F17322012	TEB	Shubham B. Kharche	<i>[Signature]</i>
74	F17322010	TEB	omkar munde	<i>[Signature]</i>
70	F17322005	TEB	Subham K.	[Signature]
71	F17322005	TEB	Gaikwad Mukesh Tony	<i>[Signature]</i>
90	F18331001	TEB	Patil Peafalla R.	<i>[Signature]</i>
79	F17322015	TE-B	Karpude M.D	<i>[Signature]</i>
69	F17322004	TE B	Borhamesh-S. Yellankar	<i>[Signature]</i>
47	F16312051	TEB	Omkar J. Gurant	<i>[Signature]</i>

Mr. K. A. Mahajan
 Activity Organiser

[Signature]
 Resource Person
 BAKER GAUGE IND PVT LTD

Page (06/06)



MES College of Engineering, PUNE-411001
Department of Mechanical Engineering



MES College of Engineering, PUNE-411001
Department of Mechanical Engineering

ATTENDANCE REPORT Date: 18/05/2018

Name of Activity : Industrial visit to BAKER GAUGE IND PVT LTD

Roll No	PRN	Class	Name of Student	Signature
70	F1732205	TE Mech II	fooja R. Kabbe	
57	F1631209	TE Mech II	Akshay Ganesh Bhosale	
50	F16312054	II	Aditya D. Deo	
72	F17322097	TE Mech 2	Ankit Arun Kamble	
61	F17321021	TE Mech 2	Atharva Jan. Kulkarni	
77	F1732203	TE Mech 2	Rahul Anon. R.	
65	F16312028	TE Mech 2	Pavni Anskita	
48	F16312052	TE Mech 2	Vasudha Shivaji Purod	
44	F16312041	TE Mech 2	Dhweta Balaso Patil	
46	F16312080	TE Mech 2	Sneha sunil Lokate	
83	F15312004	TE mech 2	Jawale Mayuri Machindra	
84	F14311025	TE mech 2	Pushkraj s. Kharat	
81	F16321006	TE Mech II	Mate Akshay. P.	
86	F1411064	TE Mech II	Shubham Kerkar	
82	F16312043	TE Mech II	Geetkand Ashish K.	
53	F16312057	TE mech II	Rohan Koshti	
49	F16312053	TE Mech II	Akash - T. Takare	
45	F16312049	TE mech II	Pawas Pravin Vile	
63	F17321022	TE Mech II	Siddhant Santosh Sawant	
13	F16312013	TE Mech II	Sai Kulkarni	
54	F16312058	TE Mech 2	stripiya Modale	

Mr. K. K. Mahajan
 Activity Organiser

Resource Person
 BAKER GAUGE IND PVT LTD



MES College of Engineering, PUNE-411001
Department of Mechanical Engineering



MES College of Engineering, PUNE-411001
Department of Mechanical Engineering

TE-B ATTENDANCE REPORT Date: 18/09/2018

Name of Activity : Industrial visit to BAKER GAUGE IND PVT LTD

Roll No	PRN	Class	Name of Student	Signature
19	F16312019	TE-Mech II	Tanmay Tekawade	
27	F16312029	TE-Mech II	AKASH MARRALI	
12	F16312012	-II-	Prasad Kadam	
16	F16312016	-II-	Chinmay G. Lokhande	
18	F16312018	-II-	Nirad B. Khale	
17	F16312017	-II-	Amrta Patil	
08	F16312008	-II-	Arshis Anzite	
58	F16312058	-II-	Atharav Meshy	
55	F16312055	-II-	Sumit Pawar	
16	F16312016	-II-	Aditya. Khedilkar	
39	F16312042	-II-	Sagar B. Jadhav	
59	F16312059	-II-	Ashwini L. Wadgaonkar	
07	F16312007	-II-	Ruchikesh R. Kherch.	
34	F16312034	-II-	Yugandhar Karnik	
37	F16312037	-II-	Shubham S. Bhai	
15	F16312015	-II-	Pranav Divekar	
62	F17310162	-II-	Sruvika Jais	
54	F17310164	-II-	Shilpi S. Shelke	
36	F16312036	-II-	Ushade Suraj Deepak	
31	F16312031	-II-	Rajnish Chaudhary	
56	F16312056	-II-	Garvish S. Shetty	

Mr. K. A. Mahajan
 Activity Organiser

Resource Person
 BAKER GAUGE IND PVT LTD



MES College of Engineering, PUNE-411001
Department of Mechanical Engineering



MES College of Engineering, PUNE-411001
Department of Mechanical Engineering

ATTENDANCE REPORT Date: 18/05/18

Name of Activity : Industrial visit to BAKER GAUGE IND PVT LTD

Roll No	PRN	Class	Name of Student	Signature
50	F16311062	TE Mech-I	Aditya Jagtap	<i>[Signature]</i>
28	F16311031	TE Mech-I	Omkar Maheshi	<i>[Signature]</i>
33	F16311037	TE Mech-I	Pranav Ladkat	<i>[Signature]</i>
40	F16311045	TE Mech-I	Vaibhav Kale	<i>[Signature]</i>
69	F17321006	TE Mech-I	Bhavesh Sani	<i>[Signature]</i>
65	F17321005	TE Mech-I	Ravindra Patil	<i>[Signature]</i>
34	F16311039	TE Mech-II	Ganesh More	<i>[Signature]</i>
18	F16311029	TE Mech-I	Krishikesh Thople	<i>[Signature]</i>
78	F17321015	TE Mech-I	Vaibhav Gund	<i>[Signature]</i>
61	F16311151	TE Mech-I	Azeeb Khan	<i>[Signature]</i>
73	F17321010	TE Mech-I	Amit Jayant Ishikarwar	<i>[Signature]</i>
72	F17321009	TE Mech-I	Omkar H. Danane	<i>[Signature]</i>
87	F15312063	TE Mech-II	Omkar G. Kunje	<i>[Signature]</i>
31	F16311035	TE Mech-I	Vishakha S. Pawar	<i>[Signature]</i>
85	F16311061	TE Mech-I	Amit D. More	<i>[Signature]</i>
83	F14311022	TE Mech-I	Kartik Varne	<i>[Signature]</i>

[Signature]
 Mr. K. A. Mahajan
 Activity Organiser

[Signature]
 Resource Person
 BAKER GAUGE IND PVT LTD



MES College of Engineering, PUNE-411001
Department of Mechanical Engineering



MES College of Engineering, PUNE-411001
Department of Mechanical Engineering

ATTENDANCE REPORT Date: 18/03/18

Name of Activity : Industrial visit to BAKER GAUGE IND PVT LTD

Roll No	PRN	Class	Name of Student	Signature
2	F16311003	TE mech-2	Yogesh Kahat	[Signature]
45	F16311053	TE mech-1	Prathamesh. Dootkar	[Signature]
42	F16311047	TE Mech-1	Prathamesh Nagul	[Signature]
37	F16311049	TE mech-2	Pratik Padman	[Signature]
59	F15311001	TE mech-1	Pratik P. mane	[Signature]
14	F16311016	TE Mech-I	Rajans Uralwar	[Signature]
04	F16311005	TE MECH1	Rohan Mane	[Signature]
16	F16311018	TE MECH1	Aniket Jable	[Signature]
39	F16311044	TE Mech-1	Animesh Deshmukh	[Signature]
60	F15311063	TE mech-1	Sable Dattaraj	[Signature]
41	F16311046	TE Mech-2	Kaustubh W. Nalawade	[Signature]
03	F16311004	TE mech-1	Nilesh Patil	[Signature]
47	F16311058	TE Mech-1	Abhijeet Papadnis	[Signature]
49	F16311061	TE Mech	Abhishek S. Dhamdhare	[Signature]
53	F16312005	TE mech-1	Sunil Tambe	[Signature]
29	F16311033	TE mech-1	Siddhant Patil	[Signature]
7	F16311000	TE Mech-1	Rahul Basbole	[Signature]
84	F15311040	TE Mech-1	Aditya Barakhe	[Signature]
32	F16311036	TE Mech-1	Angana Saha	[Signature]
46	F16311055	TE Mech-1	Vedant Gunjkar	[Signature]
54	F15312003	TE MECH-2	Vishal Suryawade	[Signature]

Mr. K. A. Mahajan
 Activity Organiser

Resource Person
 BAKER GAUGE IND PVT LTD



MES College of Engineering, PUNE-411001
Department of Mechanical Engineering



MES College of Engineering, PUNE-411001
Department of Mechanical Engineering

TE-A **ATTENDANCE REPORT** Date: 18/09/2018
 Name of Activity : Industrial visit to BAKER GAUGE IND PVT LTD

Roll No	PRN	Class	Name of Student	Signature
82	F15311000	TE Mech I	Tejas Deo	
71	F17321001	TE Mech I	Akanksha Ichale	
70	F1732201	TE Mech I	Dhaneshree Rane	
75	F17321012	TE Mech I	Shela L. Pawar	
68	F17321005	TE Mech I	Rutuja Dalas	
81	F17321006	TE Mech I	Ashwini Deore	
01	F16311002	TE Mech I	Shruti Das	
35	F16311000	TE Mech I	Gurukulij Y. Wale	
19	F1631102	TE Mech I	Anupam P. Mahale	
66	F17322003	TE Mech I	Kunal V. Barambale	
79	F17321016	TE Mech I	Batav Shriram Sahaboo	
64	F17321001	TE Mech I	Siddhant D. Sinha	
21	F16311023	TE Mech I	Murumadhi - K	
25	F1631102	TE Mech I	SHUBHAM THOK	
06	F16311007	TE Mech I	Pravin Gudihindia	
15	F16311017	TE Mech I	Tanmay Thariat	
17	F16311019	TE Mech I	Atharva Tungikar	
22	F16311014	TE Mech I	Rohit Sangle	
20	F16311022	TE Mech I	Nikhil Mahajan	
24	F16311024	TE Mech I	Jayesh Hair	
9	F16311009	TE Mech I	Pratik Kobil	

Mr. K. A. Mahajan
 Activity Organiser

Resource Person
 BAKER GAUGE IND PVT LTD



MES College of Engineering, PUNE-411001
Department of Mechanical Engineering

CERTIFICATE

Monday 24/09/2018

This is to certify that **Mr. K. A. Mahajan & Mr. P. S. Pandure** has completed the **Industrial visit to BAKER GAUGE IND PVT LTD** activity from **18/09/2018 to 18/09/2018**.

Duty leave can be **Considered / Not Considered** for above faculties from **18/09/2018 to 18/09/2018**

HoD

Mechanical Engineering



MES College of Engineering, Pune-01



Department of E&TC

BSNL RTTC VISIT REPORT

BSNL is offering Free Training to the Unemployed youth on various Telecom Technologies with the support of Government of India under the Scheme Pandit Deendayal Upadhyaya Sanchar Kaushal Vikas Pratisthans (PDDU).

Objective of the scheme is to cater to the needs of skilled manpower for 'BharatNet' the flagship project of DoT aimed to provide digital connectivity to villages. Participants can opt any one training out of three trainings as mentioned below:

- Broadband Technician (only for Pune region)
- Tower Technician
- Optical Fibre Technician

Training outcome :

After completing this programme, participants will be able to:

Aggregate awareness of mining and equipment installation and configuring CPE: arrange and check access to site, tools, and cables according to guidelines

Comprehend and initiate the importance of reporting and recording: ensure all reports, CPE configurations, settings, and faults are documented for future reference.

Establish connection amongst service provider gateway, CPE and user device: ensure connectivity, settings and tests are properly executed.

Identify , locate and execute CPE faults, cable and connector faults: understand different types of cables, correct pairs, software required for installation and various tests for troubleshooting

Training Duration : 300 Hrs.

Certification : Certificate will be provided after successful completion of third party assessment.

Training charges : It is a Government aided scheme hence no training fee will be charged.

Total No. of students registered :109

No. of students failed :04

No of students absent: 02

Dates: Internship starts from April 2019.





Prof. M. M. Dhanvijay
Visit Coordinators

Prof. P B Chopade
HOD



MES College of Engineering, PUNE-411001
Department of Mechanical Engineering

Ref No.

Date : Monday 24/05/2021

Activity : **Guest Lecture**

Name of Activity: **Webinar on Internship opportunities EV and core areas of mechanical Engineering.**

Objectives of Activity: To prepare students for

- 1 To educate student about internship opportunities in EV and Core areas of mechanical engineering
- 2 To make aware student about different awareness courses in Electric Vehicle
- 3
- 4

Target group: SE, TE, BE Mechanical

Number of Present Students: 184

Total Number of targeted group of Students: 400

Resource Person Details

Name of Resource Person: Mr. Vikas Sharma,
Designation: Assistant Manager
Organisation / institute: ISIEINDIA, Noida, Delhi

Activity Schedule

Duration : 17/05/2021 to 17/05/2021
Time : 02:00 PM
Venue: Online

Activity Organised by: Mr. A. R. Patil

Faculty Associated : Mr.R.N.Yerrawar

Brief Description of Activity:

The session started with welcome and Introduction of guests and few encouraging word by Dr. Sarawade Sir and Dr. Chougule Sir. In this webinar , Mr Raunak Choudhary Sr. Engg, ISIEINDIA started with discussion on Electric Vehicles and their scope in coming years. He also explain the basic of Electric vehicle and different areas where student can make career. After his technical session, Q & A session were conducted with students to solve the doubt regarding electric vehicles. Afterward Vikas Sharma -Asst Manager, ISIEINDIA explained about different internship program in EV and other core areas along with content. The session ended with vote of thanks by Dr. A. R. Patil. This session conducted under IIC MESCOE.



MES College of Engineering, PUNE-411001 Department of Mechanical Engineering

Activity Photographs

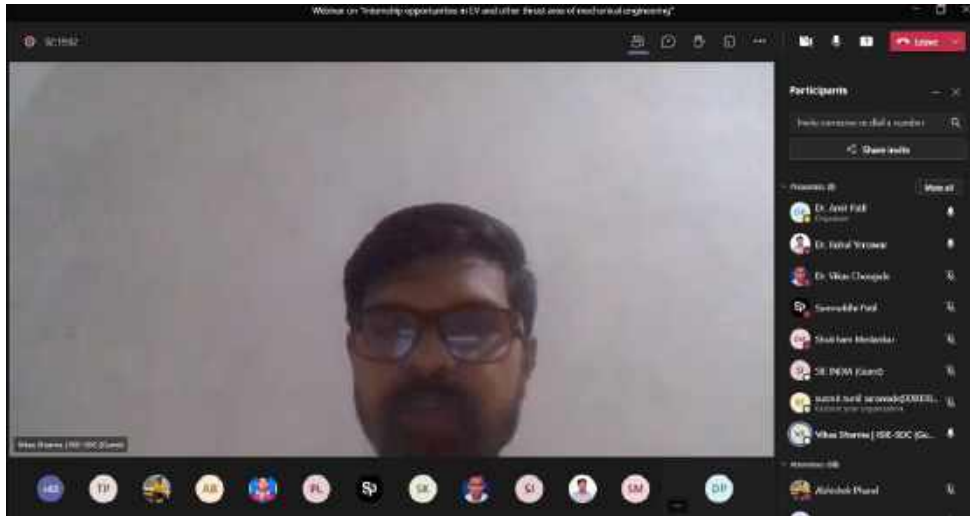



MES College of Engineering, PUNE-411001
Department of Mechanical Engineering

Attendance Certificate

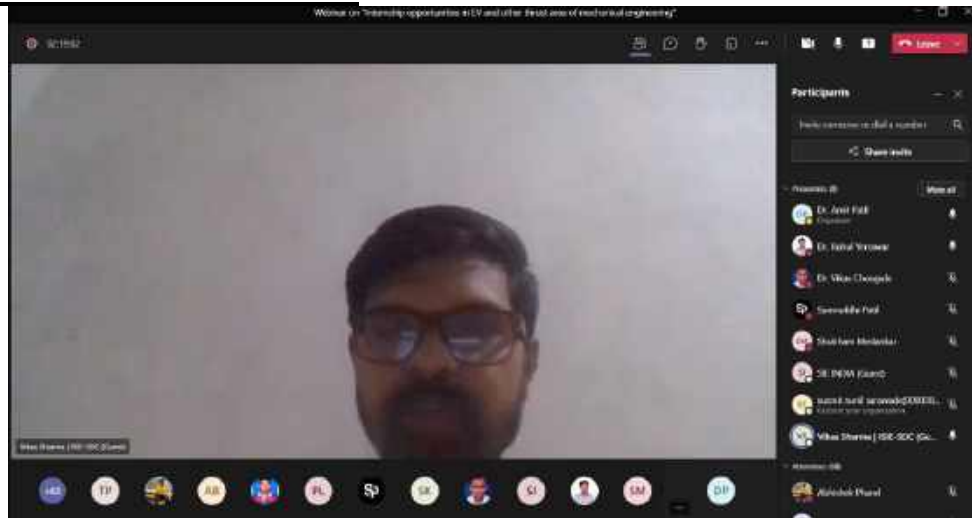



MES College of Engineering, PUNE-411001
Department of Mechanical Engineering

Activity to PO linking: 1: Slight (Low), 2: Moderate (Medium), 3: Substantial (High)

PO1	PO2	PO3	PO4	PO5	PO6	PO7	PO8	PO9	PO10	PO11	PO12	PO13	PO14	PO15
1	0	2	0	2	0	3	0	1	0	0	0	3	0	0

Activity to PO Linking Justification

PO No	Level (1,2,3)	Justification For Activity to PO Linking in Level (1,2,3)
PO1	1	Electric vehicles need understanding of basic of mechanical engineering
PO2	0	
PO3	2	Student need to design different component of electric vehicle along with battery management that involve critical problem solving and thinking
PO4	0	
PO5	2	Use of modern technology of electrification of conventional IC Engine is involved along with simulation of heat management of battery
PO6	0	
PO7	3	Electric vehicle technology is one of the step toward green energy and clean emission.
PO8	0	
PO9	1	During internship student need to work with team involving other students, supervisor hence build team work skill
PO10	0	
PO11	0	
PO12	0	
PO13	3	Principal of thermal , design and production is involve in the development and manufacturing of electric vehicle
PO14	0	
PO15	0	

Mr. A. R. Patil
Activity Organiser

HoD
Mechanical Engg. Dept.



MES College of Engineering, PUNE-411001
Department of Mechanical Engineering

ATTENDANCE REPORT

Yash Sakhal	Joined	5/17/2021, 2:10:25 PM
Rubaj Kankate	Joined	5/17/2021, 2:10:25 PM
SURAJ WAGH	Joined	5/17/2021, 2:10:26 PM
Rohit Pawale	Joined	5/17/2021, 2:10:27 PM
Bhavesh Bhosale	Joined	5/17/2021, 2:10:29 PM
Chetan Gaikwad	Joined	5/17/2021, 2:10:31 PM
Ashishek Adhav	Joined	5/17/2021, 2:10:31 PM
Shubham Sarank	Joined	5/17/2021, 2:10:33 PM
Mohammad Farr	Joined	5/17/2021, 2:10:35 PM
Shreya Sakore	Joined	5/17/2021, 2:10:36 PM
Gaurav Baljirab	Joined	5/17/2021, 2:10:39 PM
Yashravi Timun	Joined	5/17/2021, 2:10:41 PM
Nachiket Deshpande	Joined	5/17/2021, 2:10:42 PM
Pratik Ghugarkar	Joined	5/17/2021, 2:10:43 PM
Gaurav Kelata	Joined	5/17/2021, 2:10:44 PM
Siddhant Vahane	Joined	5/17/2021, 2:10:45 PM
Tushar Swami	Joined	5/17/2021, 2:10:48 PM
Naseem Sayyed	Joined	5/17/2021, 2:10:54 PM
Yash Agrawal	Joined	5/17/2021, 2:10:54 PM
Sanket Mahale	Joined	5/17/2021, 2:10:56 PM
Karan Gandhi	Joined	5/17/2021, 2:10:57 PM
ANKET DHOLE	Joined	5/17/2021, 2:11:04 PM
Anushka Patil	Joined	5/17/2021, 2:11:10 PM
Vahwansaj Bhilare	Joined	5/17/2021, 2:11:17 PM
Pratik Deshmukh	Joined	5/17/2021, 2:11:20 PM
Aniket Joshi	Joined	5/17/2021, 2:11:38 PM
Waman Mujawar	Joined	5/17/2021, 2:11:44 PM
Vijay Pawar	Joined	5/17/2021, 2:11:44 PM
Nikhil Patil	Joined	5/17/2021, 2:11:44 PM
Aditya Dastur	Joined	5/17/2021, 2:11:45 PM

Gajendra Bag	Joined	5/17/2021, 2:03:30 PM
Jayesh Mahale	Joined	5/17/2021, 2:03:36 PM
Rajawase Dajad	Joined	5/17/2021, 2:03:44 PM
Nikhil Barate	Joined	5/17/2021, 2:03:54 PM
Shrawan Sarad	Joined	5/17/2021, 2:04:00 PM
Semrudhikha Shek	Joined	5/17/2021, 2:04:06 PM
VISHAL MISHRA	Joined	5/17/2021, 2:04:25 PM
Gargi Kulkarni	Joined	5/17/2021, 2:04:35 PM
Yash Sora	Joined	5/17/2021, 2:04:43 PM
SALURAV SHIND	Joined	5/17/2021, 2:05:36 PM
Shambhuj Rajat	Joined	5/17/2021, 2:05:45 PM
Kshitij Raskar	Joined	5/17/2021, 2:05:50 PM
Ninad Kalekar	Joined	5/17/2021, 2:05:50 PM
AJAY SONAWAR	Joined	5/17/2021, 2:06:00 PM
Vikas Sharma I	Joined	5/17/2021, 2:06:14 PM
Bhavansh Suryak	Joined	5/17/2021, 2:06:18 PM
Tejas Deshmukh	Joined	5/17/2021, 2:06:46 PM
Shubham Thile	Joined	5/17/2021, 2:07:44 PM
Prasad Gaikwad	Joined	5/17/2021, 2:07:55 PM
Kartik Joshi	Joined	5/17/2021, 2:08:06 PM
Dhiraj Deshmukh	Joined	5/17/2021, 2:08:14 PM
Shubham Bhatik	Joined	5/17/2021, 2:08:37 PM
SOMNATH SAPI	Joined	5/17/2021, 2:09:22 PM
Shubham Nagan	Joined	5/17/2021, 2:09:30 PM
Rishabh Chaudh	Joined	5/17/2021, 2:09:59 PM
Omkar Pawale	Joined	5/17/2021, 2:10:06 PM
Ninad Salunkhe	Joined	5/17/2021, 2:10:13 PM
Vishal Patil	Joined	5/17/2021, 2:10:18 PM
Suraj Antrakar	Joined	5/17/2021, 2:10:22 PM
Mihika Desai	Joined	5/17/2021, 2:10:23 PM



MES College of Engineering, PUNE-411001
Department of Mechanical Engineering

Aharon Shandor	Joined	5/17/2021, 1:59:58 PM
Rushikesh Patil	Joined	5/17/2021, 2:00:04 PM
Akshay Mehta	Joined	5/17/2021, 2:00:21 PM
Himanshu Astu	Joined	5/17/2021, 2:00:31 PM
Ashutosh Phand	Joined	5/17/2021, 2:00:33 PM
Dr. Anshu Mitra	Joined	5/17/2021, 2:00:34 PM
Tapasya Patil	Joined	5/17/2021, 2:00:43 PM
Niyati Shinde	Joined	5/17/2021, 2:00:48 PM
Yash Kulk	Joined	5/17/2021, 2:00:52 PM
Sanket Kathe	Joined	5/17/2021, 2:00:56 PM
Adhijest Gavhan	Joined	5/17/2021, 2:01:07 PM
Omkar Thite	Joined	5/17/2021, 2:01:16 PM
Ajay Patil	Joined	5/17/2021, 2:01:31 PM
Aditi Sontawane	Joined	5/17/2021, 2:01:38 PM
Kunal Patil	Joined	5/17/2021, 2:01:48 PM
YASHVI NAGAI	Joined	5/17/2021, 2:01:50 PM
Tejas Jagtap	Joined	5/17/2021, 2:01:53 PM
Tushar Ghogre	Joined	5/17/2021, 2:02:06 PM
Swapnil Rogade	Joined	5/17/2021, 2:02:15 PM
Rishabh Banarase	Joined	5/17/2021, 2:02:15 PM
Tejasa Patil	Joined	5/17/2021, 2:02:18 PM
Muzet Patil	Joined	5/17/2021, 2:02:18 PM
Abdulah Mukad	Joined	5/17/2021, 2:02:20 PM
Omkar Deshpande	Joined	5/17/2021, 2:02:29 PM
Priyanka Jalgaon	Joined	5/17/2021, 2:02:30 PM
Ashish Thite	Joined	5/17/2021, 2:02:38 PM
Gaurav Mahapatra	Joined	5/17/2021, 2:02:58 PM
Prasad Lokhande	Joined	5/17/2021, 2:03:05 PM
Sudesh Vasth	Joined	5/17/2021, 2:03:10 PM
Krushna Rashink	Joined	5/17/2021, 2:03:20 PM

Full Name	User Action	Timestamp
Dr. Anil Patil	Joined	5/17/2021, 1:29:39 PM
Dr. Rishabh Yerraw	Joined before	5/17/2021, 1:29:39 PM
Anup Patil	Joined	5/17/2021, 1:47:11 PM
Shubham Medar	Joined	5/17/2021, 1:48:02 PM
Sachin Kambhark	Joined	5/17/2021, 1:48:25 PM
Samrudhi Patil	Joined	5/17/2021, 1:49:06 PM
OMKAR GURAV	Joined	5/17/2021, 1:51:58 PM
Mathew S Georg	Joined	5/17/2021, 1:53:44 PM
Jayesh Shewale	Joined	5/17/2021, 1:54:08 PM
Priyanka Lakari	Joined	5/17/2021, 1:54:30 PM
Sanal Sarang	Joined	5/17/2021, 1:56:30 PM
Anjali Bhat	Joined	5/17/2021, 1:57:38 PM
Sahil Ghoshle	Joined	5/17/2021, 1:57:59 PM
Vishal Gokwad	Joined	5/17/2021, 1:58:00 PM
Shreyash Patil	Joined	5/17/2021, 1:58:06 PM
Sourav Gupte	Joined	5/17/2021, 1:58:07 PM
Omkar Karad	Joined	5/17/2021, 1:58:40 PM
Manas Ghodke	Joined	5/17/2021, 1:58:47 PM
Shubham Gede	Joined	5/17/2021, 1:58:55 PM
susmit suri karia	Joined	5/17/2021, 1:58:59 PM
Vivekanand Laha	Joined	5/17/2021, 1:59:02 PM
Munad Shedge	Joined	5/17/2021, 1:59:07 PM
Brushan Patil	Joined	5/17/2021, 1:59:09 PM
Tanmay Shekh	Joined	5/17/2021, 1:59:13 PM
Satyam Somnare	Joined	5/17/2021, 1:59:20 PM
Prathvishth Kad	Joined	5/17/2021, 1:59:28 PM
Utsav Dube	Joined	5/17/2021, 1:59:48 PM
Ganesh Omkase	Joined	5/17/2021, 1:59:53 PM
Sanyuk Khande	Joined	5/17/2021, 1:59:55 PM



MES College of Engineering, PUNE-411001
Department of Mechanical Engineering

Ankit Jadhav	Joined	5/17/2021, 3:05:12 PM
Bincha Warve	Joined	5/17/2021, 3:10:56 PM
Ketaki Mahajan	Joined	5/17/2021, 3:17:31 PM
Rushan Patole	Joined	5/17/2021, 3:17:40 PM
Shardul Ashlekar	Joined	5/17/2021, 3:19:01 PM
Shreehanh Para	Joined	5/17/2021, 3:25:00 PM
Pragyesh Potti	Joined	5/17/2021, 3:29:09 PM
Konni Shelar	Joined	5/17/2021, 3:31:10 PM
Shardul Patilkar	Joined	5/17/2021, 3:57:18 PM
Purnesh Salva	Joined	5/17/2021, 4:08:40 PM

Nikita Shondave	Joined	5/17/2021, 2:17:00 PM
WANTASHINGA	Joined	5/17/2021, 2:17:24 PM
Aditya Galwad	Joined	5/17/2021, 2:17:59 PM
Prayal Pali	Joined	5/17/2021, 2:18:28 PM
Kedari Mohar	Joined	5/17/2021, 2:19:00 PM
Shreya Londhe	Joined	5/17/2021, 2:20:13 PM
ARFAT CHAUHAN	Joined	5/17/2021, 2:21:00 PM
Manasi More	Joined	5/17/2021, 2:21:45 PM
Manohar Namad	Joined	5/17/2021, 2:22:10 PM
Shivam Galwad	Joined	5/17/2021, 2:22:28 PM
NIRAJ ADSULE	Joined	5/17/2021, 2:23:49 PM
Vikas Sharma (G)	Joined	5/17/2021, 2:24:52 PM
Nikhi Jadhve	Joined	5/17/2021, 2:26:01 PM
Rohit Desre	Joined	5/17/2021, 2:27:51 PM
Aniket Gawande	Joined	5/17/2021, 2:29:51 PM
Shreya Kulkarni	Joined	5/17/2021, 2:30:22 PM
Shriyash Waghre	Joined	5/17/2021, 2:32:30 PM
Shriyash Daven	Joined	5/17/2021, 2:32:34 PM
Yogesh Mandik	Joined	5/17/2021, 2:35:10 PM
Sharvin Tagunde	Joined	5/17/2021, 2:36:30 PM
PRITHVIRAJ AS	Joined	5/17/2021, 2:38:13 PM
Mohammadali In	Joined	5/17/2021, 2:38:49 PM
Mayurak Pali	Joined	5/17/2021, 2:40:06 PM
Sagar Pandit	Joined	5/17/2021, 2:44:31 PM
SIE INDIA (Gues	Joined	5/17/2021, 2:52:15 PM
Ashishk Pali	Joined	5/17/2021, 2:54:13 PM
Shubhang Sonu	Joined	5/17/2021, 2:55:16 PM
Maneesh Pende	Joined	5/17/2021, 2:58:41 PM
Vishravi Kalshe	Joined	5/17/2021, 3:03:04 PM
Pooja Biswas	Joined	5/17/2021, 3:03:35 PM



MES College of Engineering, PUNE-411001
Department of Mechanical Engineering

Raj Chougale	Joined	5/17/2021, 2:11:47 PM
Ganesh Kulkarni	Joined	5/17/2021, 2:11:47 PM
Vishnu Ghate	Joined	5/17/2021, 2:11:58 PM
Niharika Kavathe	Joined	5/17/2021, 2:11:58 PM
Vishal Kulkarni	Joined	5/17/2021, 2:12:01 PM
Amey Pawarane	Joined	5/17/2021, 2:12:06 PM
Aditya Patil	Joined	5/17/2021, 2:12:15 PM
Rajyesh Shalkh	Joined	5/17/2021, 2:12:24 PM
Rushikesh Deshi	Joined	5/17/2021, 2:12:37 PM
Ravindra More	Joined	5/17/2021, 2:12:37 PM
Sanket Kasar	Joined	5/17/2021, 2:12:43 PM
Shantanu Jambor	Joined	5/17/2021, 2:12:51 PM
Sampada Neshit	Joined	5/17/2021, 2:12:51 PM
Digvijay Boya	Joined	5/17/2021, 2:13:04 PM
Shrutadheep Mule	Joined	5/17/2021, 2:13:10 PM
Anushka Archar	Joined	5/17/2021, 2:13:25 PM
Chaitanya Chaur	Joined	5/17/2021, 2:13:25 PM
Vaishnavi Bhor	Joined	5/17/2021, 2:13:36 PM
Bhavesh Gaware	Joined	5/17/2021, 2:13:48 PM
Ayusha Bhoj	Joined	5/17/2021, 2:13:53 PM
Swapnil Patil	Joined	5/17/2021, 2:14:01 PM
Jharuti Raut	Joined	5/17/2021, 2:14:33 PM
ANIL BHURKE	Joined	5/17/2021, 2:14:45 PM
SAIDHAN PWARA	Joined	5/17/2021, 2:15:13 PM
Ahanya Nambare	Joined	5/17/2021, 2:15:21 PM
Hibik Kambhoj	Joined	5/17/2021, 2:15:44 PM
Dr. Vikas Chougale	Joined	5/17/2021, 2:15:48 PM
Rachana Bhokar	Joined	5/17/2021, 2:16:01 PM
Ashish Thombare	Joined	5/17/2021, 2:16:16 PM
Swapnil Botre	Joined	5/17/2021, 2:16:46 PM



MES College of Engineering, PUNE-411001
Department of Mechanical Engineering

CERTIFICATE

Monday 24/05/2021

This is to certify that **Mr. A. R. Patil & Mr.R.N.Yerrawar** has completed the **Webinar on Internship opportunities EV and core areas of mechanical Engineering** activity from **17/05/2021 to 17/05/2021**.

Duty leave can be **Considered / Not Considered** for above faculties from **17/05/2021 to 17/05/2021**

HoD

Mechanical Engineering

Modern Education Society's College of Engineering Pune-01

Department of Electronics & Telecommunication

INNERVE 2020 (ETSA) REPORT

INTRODUCTION

A Departmental fest named INNERVE was organised by E&TC students' association on 10th February 2020 at Modern Education Society's College of Engineering Pune-01.

The event was inaugurated by Principal by ribbon cutting ceremony. The fest consisted 7 events in total. They were classified as technical and non-technical events and were organised for pure fun and recreational purposes.

BRIEF SUMMARY

Sr. no	Name of Event	Event Type	Event Heads	Price Money	Registration-n Fees	No Of Participants
1	Techno-hunt	Technical event	Mudasser Shaikh	1 st -2000 2 nd 1000	50	40
2	Google charades	Technical event	Yogeshwar Sapkal	1 st -2000 2 nd -1000	50	30
3	Math-O-mania	Technical event	Pooja Mhade	1 st -2000 2 nd -1000	50	34
4	Roadies 2.0	Non-technical	Pratiksha Kamble	1 st -2000 2 nd -1000	30	48
5	Blind Puri	Non-technical	Swapnajeet Shendkar	1 st -2000 2 nd -1000	40	50
6	Sherlock Holmes	Non-Technical	Sanjana Pardeshi	1 st -2000 2 nd -1000	30	40
7	Debate	Non-technical	Pranil Sakinal	1 st -2000 2 nd -1000	10	12



Before Inauguration.



Inauguration by Curtain Opening.



After Inauguration with all the respected Dignities and ETSA Core Team.



TECHNOHUNT.



GOOGLE CHARADES.



MATH-O-MANIA.



ROADIES 2.0



BLIND PURI.



SHERLOCK HOLMES.



DEBATE COMPETITION.



AFTER EVENT.

Conclusion

In conclusion as organizers of INNERVE 2020, we congratulate all the participants and winners on the successful edition of INNERVE. According to statistics a total of participants were enlisted. On 10th scheduled events were Sherlock Holmes, Debate Competition, Blind Puri, Math-O-Mania, Techno Hunt, roadies 2.0 and Google charades. All the events were conducted very smoothly without any discrepancies. Our marketing team was ready for on spot entries and any sort of enquiries raised by participants. Each event was assigned by faculty to oversee progress and smooth flow. The Two events which attracted the crowd most was Blind Puri and Roadies 2.0 and can be considered as main highlights of the fest. Due to our team motivation and hard work we were able to pull such an event after many setbacks. The total price money given was 21000. The budget sanctioned was 42000.

Thank you.

MESCOE
Department of Computer Engineering
Guest Lecture Details
A Y 2018-19

Sr. No.	Topic	Speaker	Date
1	Guidelines for selecting BE project	Mr. Amey Paratkar (Product Manager, HARVESTGRID Ltd. Pune)	12/07/2018
2	Ethical hacking	Mr. Rizwan Shaikh , (founder Pristine Info Solution)	18/07/2018
3	Using Network Visibility to Detect Well-Hidden Threat"	Ms Lauren Horaist, Mr Thomas Obremski, (Security Intelligence Product Marketing ,IBM Security)	20/08/2018
4	Android Programming	Mrs Rashmi Tambat (Freelance Android Developer and Trainer)	24/08/2018
5	Intellectual Property Rights IPR	Mr.Vijay Bhosale, (Patent Associate – Khurana & Khurana Advocates & IP Attorneys)	07/09/2018
6	Guidelines To Create Intellectual Property	Mr.Vijay Bhosale, (Patent Associate – Khurana & Khurana Advocates & IP Attorneys)	29/09/2018
7	Carrier opportunity UI/UX	Mr. Devendra Naik (Director, P2S Information System Pvt Ltd)	01/02/2019
8	Coding standards and best practice	Mr. Sandeep (Dange ,Software Engineer, Bruvti Predictive Analytics)	11/02/2019
9	Information and cyber security	Mr. Bhushan Gaikwad(Alumni) (Founder & CEO , Engineers Connect StackZeal pvt Ltd)	19/03/2019
10	Guidelines for Abroad study	Mr. Sandeep Patil (Business Manager , IDP Education India Pvt Ltd)	19/03/2019
11	OOPs-Pure Virtual Function)	Mrs. Trupti Sathe , (Tech. Exp. And Academic Head,S, SeedInfotech Ltd)	20/03/2019
12	Data Structure- Decision Tree	Mrs. Trupti Sathe , (Tech. Exp. And Academic Head,S, SeedInfotech Ltd)	20/03/2019
13	Web Technology –	Mr. Bhushan Gaikwad(Alumni)	22/03/2019

	Node Js	(Founder & CEO , Engineers Connect StackZeal pvt Ltd)	
14	Emerging Careers	Mr. Nikhil Bhaskaran, (Founder, IOTIOT.in Ltd)	22/03/2019
15	Emerging Careers	Mr. Nikhil Bhaskaran, (Founder, IOTIOT.in Ltd)	22/03/2019
16	Emerging Careers	Mr. Nikhil Bhaskaran, (Founder, IOTIOT.in Ltd)	22/03/2019



Guest Lecture Coordinator
(Prof. S. S. Raskar)



H.O.D.
Dr. (Mrs.) N.F. Shaikh

MES College of Engineering, Pune-01
Computer Engineering Department

Guest Lecture

Date: 11th July 2018`

NOTICE

All BE Students (computer) of MESCOE are hereby informed that Computer Engineering Department is arranging Guest Lecture on “**Guideline for selecting BE project**” on 12th July 2018 at 12:30 pm in Seminar Hall (509).

Co-coordinator

Prof. S. S. Raskar



Prof. S. R. Balwan

Prof. M. A. Malwade

Prof. S. E. Ingale

Prof B. F. More



HOD

Dr. (Mrs.) N. F. Shaikh

M. E. S. College of Engg. Pane: 411 001.
Department of Computer Engineering
Guest Lecture

Date: 12 July 2018

Time: 12:30 PM to 1:30 PM

Venue: Seminar Hall 509

Topic: Guideline for selecting BE project

Speaker: Mr. Ameya Paratkar

Company Name - Harvestgold .Pune

Designation - Product manager.

 **Speaker sign**

Co-coordinator

Prof. S. S. Raskar 

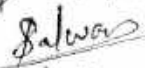
Prof. S. R. Balwan 

Prof. M. A. Malwade 

Prof. S. Inogale 

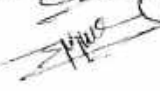
Prof B. More 

HOD

Dr. (Mrs.) N. F. Shaikh

MODERN EDUCATION SOCIETY'S COLLEGE OF ENGINEERING, PUNE-01,
DEPARTMENT OF COMPUTER ENGINEERING

Activity Report

Activity: GUEST LECTURE
Speakers: Mr. Amey Paratkar
Designation: Product Manager, Harvestgrid Tnex, Pune
Topic: Guidelines for Selecting BE project
Date: 12.07.2018
Time: 12.30 to 1.30 PM
Venue: Seminar Hall-509
Class : All BE Students (168/237)

Objectives: 1.To understand different aspects of domain for selecting project.
2. To understand importance of sponsored projects.

Outcomes: 1.Students will get guidance for how to select the BE projects.

PEOs satisfied and POs achieved:

PSOs: 1, 3 PEOs: 1,5 POs:9,11,12

Activity Report:

A guest lecture on “**Guidelines for Selecting BE project**” was successfully arranged and conducted with an excellent interactive session on 12th July 2018, by Department Of Computer Engineering, MESCOE, which witnessed an enthusiastic response and participation from all BE students. Felicitation of the speaker, **Mr. Amey Paratkar, Harvestgrid Pune** , by hands of Prof. S.S. Raskar

The whole session was totally Question-Answer and interactive session. He clears all the basic concepts of students regarding selecting BE Projects. He explained and discussed several steps involved in sponsor projects. He has given various domains idea which students can select like Networking, Data mining, IOT , Big Data etc. He then proceeded with current scenario of IT industry.

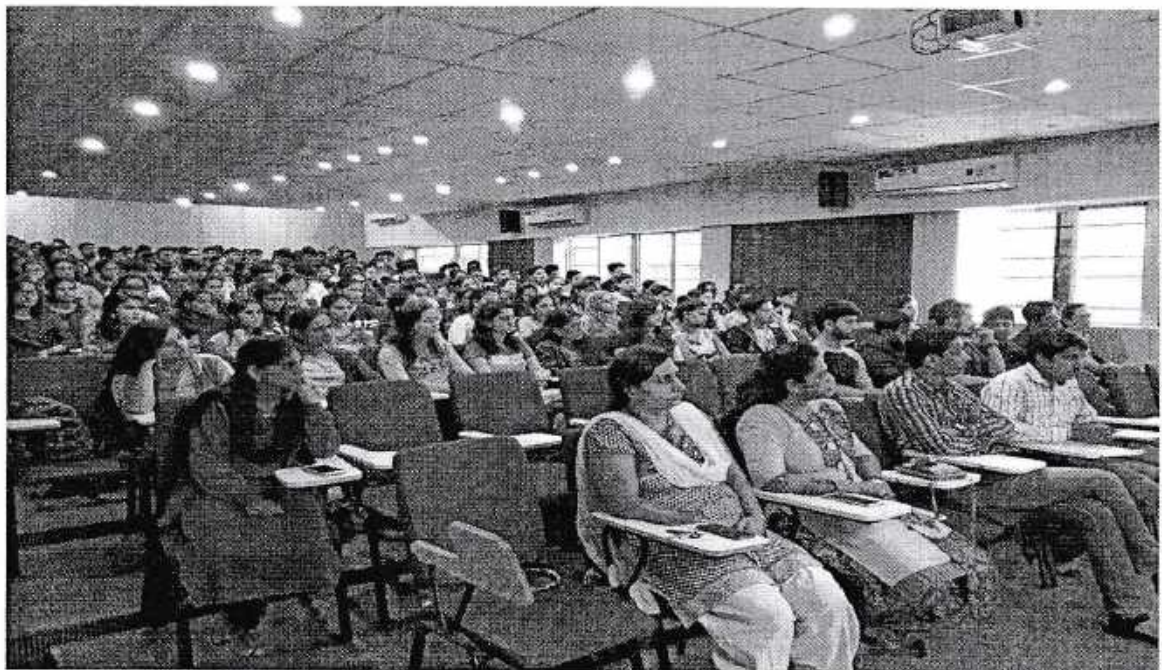

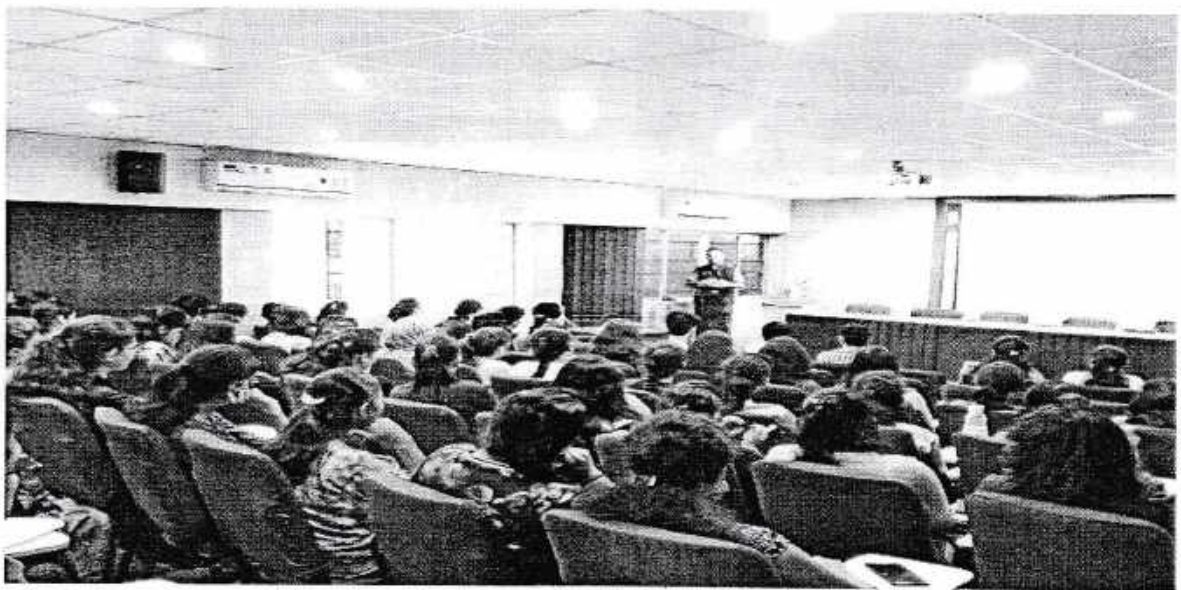

Speaker Interaction

Coordinators

Prof. S. S. Raskar

Prof. S. R. Balwan

Prof. M. A. Malwade

Prof. S. E. Ingale

Prof. B. F. More

HOD

Dr. (Mrs.) N. F. Shaikh

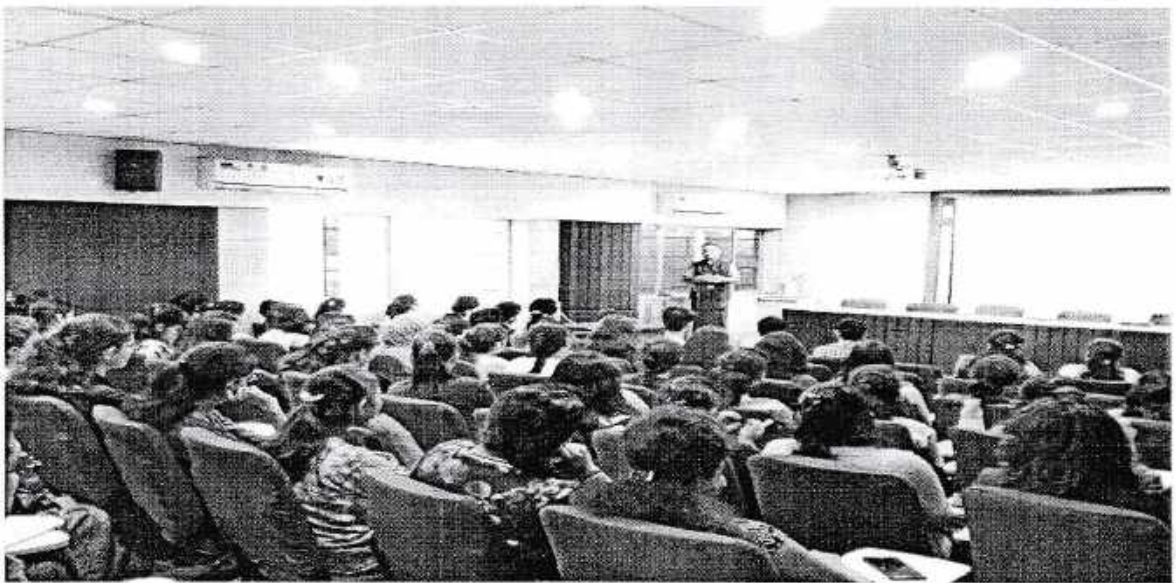

Speaker Interaction

Coordinators

Prof. S. S. Raskar

Prof. S. R. Balwan

Prof. M. A. Malwade

Prof. S. E. Ingale

Prof. B. F. More

HOD

Dr. (Mrs.) N. F. Shaikh

M. E. S. College of Engg. Pane: 411 001.
Department of Computer Engineering
Guest Lecture Attendance (BE)

Guidelines for BE Project

Topic :

Speaker :

Date: 12/07/18

Roll No.	Name	Sign
1	Ankita Milind Bhosale	<i>Ankita</i>
2	Bagwan Tanaz Javed	<i>Tanaz</i>
3	Bhoj Soham Sanjeev	<i>Bhoj</i>
4		
5	Borkar Hrishikesh Gajanan	<i>Borkar</i>
6	Chaudhari Richa Mahesh	<i>Richa</i>
7	Wani Amit Mohan	<i>Wani</i>
8	Chavan Nishant Ganesh	<i>Chavan</i>
9	Rathod Rushikesh Limchand	<i>Rathod</i>
10		
11	Dias Steffy Simon	<i>Dias</i>
12	Gandhi Pankaj Ramanlal	<i>Gandhi</i>
13	Gaurav Sarade	<i>Gaurav</i>
14	Ghag Vedant Pravin	<i>Ghag</i>
15		
16	Gurav Pranjali Ashok	<i>Gurav</i>
17	Gurav Subhadra Vijay	<i>Gurav</i>
18		
19	Akash Jadhav	<i>Akash</i>
20	Jadhav Shweta Shashikant	<i>Jadhav</i>
21	Jadhav Vipul Mahadev	<i>Jadhav</i>
22	Jaiswal Shikha Laxmikant	<i>Jaiswal</i>
23	Jambhale Kajal	<i>Jambhale</i>
24		
25	Khandagale Devika Sanjeev	<i>Khandagale</i>
26	Kochar Aayushi Kaur	<i>Kochar</i>
27	Kolapkar Pallavi Dnyaneshwar	<i>Kolapkar</i>
28	Kolhe Shweta Shriram	<i>Kolhe</i>
29	Kottur Shweta Nitin	<i>Kottur</i>
30	Kshirsagar Mansi Mahesh	<i>Kshirsagar</i>
31	Kudale Jyoti Prakash	<i>Kudale</i>
32	Kulkarni Pratiksha Sudhakar	<i>Kulkarni</i>
33	Kulkarni Sharvari Suhas	<i>Kulkarni</i>
34	Lobo Cristal Wilson	<i>Lobo</i>
35	Lokhande Ankit Sanjaykumar	<i>Lokhande</i>
36	Lokhande Priyanka Bhaurao	<i>Lokhande</i>
37		
38	Mane Shruti Shyam	<i>Mane</i>
39	Manjusha Sarang	<i>Manjusha</i>
40	More Akshata Ravindra	<i>More</i>

Roll No.	Name	Sign
41	Munshi Nuwed Nadim	<i>Munshi</i>
42	Nagadekar Aniket Dattatray	<i>Nagadekar</i>
43		
44	Natu Rutvik Milind	<i>Natu</i>
45	Nichat Rushabh Anandrao	<i>Nichat</i>
46	Nikalje Saurabh	<i>Nikalje</i>
47	Pardeshi Adesh Anil	<i>Pardeshi</i>
48	Pathrikar Shubham	<i>Pathrikar</i>
49	Patil Prajakta Pravin	<i>Patil</i>
50	Pawar Ashwini Sudhir	<i>Pawar</i>
51	Pawar Sayali Bajrang	<i>Pawar</i>
52	Pillai Rohit	<i>Pillai</i>
53	Pratiksha Ashok Chavan	<i>Pratiksha</i>
54	Purvi Sunil Modi	<i>Purvi</i>
55	Rade Pooja Narendra	<i>Rade</i>
56		
57	Sanghvi Riddhi Nilesh	<i>Sanghvi</i>
58	Rajoria Sheetal	<i>Rajoria</i>
59	Sase Swati Raosaheb	<i>Sase</i>
60	Satav Rajnandini Dnyaneshwar	<i>Satav</i>
61	Shaikh Adnan Irfan	<i>Shaikh</i>
62	More Sagar Sanjay	<i>More</i>
63	Shaikh Nida Naseer	<i>Shaikh</i>
64	Shinde Arjun Ashok	<i>Shinde</i>
65	Khomane Sayali Sudhakar	<i>Khomane</i>
66	Shinde Ruchi Pramod	<i>Shinde</i>
67	Shinde Supriya Kinchak	<i>Shinde</i>
68	Shinde Tushar Mahesh	<i>Shinde</i>
69	Shitole Rutuja Rajendra	<i>Shitole</i>
70	Shivani Mukundsingh Thakur	<i>Shivani</i>
71	Kudale Twinkle Ramdas	<i>Kudale</i>
72	Sonawane Sagar Ashok	<i>Sonawane</i>
73	Wabale Prachi Yashavant	<i>Wabale</i>
74	Waghmode Vithal Arun	<i>Waghmode</i>
75	Yadav Harshada Dilip	<i>Yadav</i>
76	Gadekar Nirmal Bhagwan	<i>Gadekar</i>
77	Nayan Bahirame	<i>Nayan</i>
78	Tejaswini Bhukan	<i>Tejaswini</i>

M. E. S. College of Engg. Pane: 411 001.
Department of Computer Engineering
Guest Lecture Attendance (BE)

Topic :

Speaker :

Date: 12/07/18

Roll No.	Name	Sign
1	Akshay Bhat	Akshay
2	Barure Kapil Dnyanoba	Kapil
3	Bhalerao Sushant Surendra	Sushant
4	Bhambure Swapnil Mahesh	Swapnil
5	Choudhary Jitendra Nemichand	Jitendra
6	Cyril Sakaria Jose	Cyril
7	Fernandes Jennifer Carlos	Jennifer
8	Garje Yogita Ramdas	Yogita
9	Gaurav Bharat Dhande	Gaurav
10	Godgul Rishika Rajesh	Rishika
11	Hirve Nitin Shankar	Nitin
12	Jagtap Sushil Narayan	Sushil
13	Jain Akshay Arun	Akshay
14	Jain Pallavi	Pallavi
15	Jasmin Yusuf Mulla	Jasmin
16	Kamthe Vaishnavi Milind	Vaishnavi
17	Kamthe Vaishnavi Milind	Vaishnavi
18	Khareshiya Anita Kumari Balbir	Anita
19	Kolte Gauri Sayaji	Gauri
20	Mirani Ghazala Sahil	Ghazala
21	Moray Shivam Chetan	Shivam
22	Nemade Hitesh Pravin	Hitesh
23	Nikharge Samira Madhav	Samira
24	Pandhare Tushar Arjun	Tushar
25	Panthaki Urmez Anushad	Urmez
26	Parkar Rameez Khalil	Rameez
27	Paste Asawari	Asawari
28	Patil Bhavesh Rajendra	Bhavesh
29	Poduval Aditya Anil	Aditya
30	Prakash D Patel	Prakash
31	Prashant Vishwakarma	Prashant
32	Rahul Dattaram Pawar	Rahul
33	Sahil Shitole	Sahil
34	Salunke Nikita Vikas	Nikita
35	Sawant Uday Motiram	Uday
36	Shah Afreen Bano	Afreen
37	Shah Karan Sandeep	Karan
38	Shaikh Md Saifuddin Saleem	Saifuddin
39	Shingade Shubham Babasaheb	Shubham
40	Shrivastava Abhishek Ashwin	Abhishek
*	Hire Laxmikant Sharad	Laxmikant

Roll No.	Name	Sign
41	Sushila Shivilal Choudhari	Sushila
42	Tambare Dhiraj Suresh	Dhiraj
43	Ujeniya Aditya Ashok	Aditya
44	Wavhal Madhuri Kalidas	Madhuri
45	Yashraj Sen	Yashraj
46	Abhijeet Subhash Doke	Abhijeet
47	Adsul Diksha Vilas	Diksha
48	Chougule Swarali Netaji	Swarali
49	Dhanwate Yogita Nivrutti	Yogita
50	Dheeraj Agrawal	Dheeraj
51	Ghodake Yogini Ramdas	Yogini
52	Gosavi Pallavi(Repeater)	Pallavi
53	Jagtap Manali Ramdas	Manali
54	Jawale Deepali Subhash	Deepali
55	Kauthale Rutuja Popat	Rutuja
56	Khan Tazeen Firoz	Tazeen
57	Kshitij Agrawal M	Kshitij
58	Mahashikare Shraddha Satish	Shraddha
59	Rahul Deshmukh	Rahul
60	Sharvari Kamble	Sharvari
61	Somesh Pathak	Somesh
62	Tathe Harshal	Harshal
63	Vikrant Ujjwal Karawande	Vikrant
64	Akhilesh Kalebere	Akhilesh
65	Anurag Gajare	Anurag
66	Bhagia Rahul Manohar	Rahul
67	Gaikwad Kunal Sureshkumar	Kunal
68	Kapadnis Shubham Keda	Shubham
69	Narawade Hrutuja Kantilal	Hrutuja
70	Nikam Rohan Sanjay	Rohan
71	Ovhal Pratiksha Balkrishna	Pratiksha
72	Patil Mayuri	Mayuri
73	Pranil Bari	Pranil
74	Sarda Bhagyashri Kedarnath	Bhagyashri
75	Shaikh Ibtesham Fareeduddin	Ibtesham
76	Shivsagar Maykar	Shivsagar
77	Stavan Salve	Stavan
78	Titar Akshay Vikas	Titar
79	Vaidya Abhishek Rameshwar	Abhishek
80	Virkar Sulbha Shivaji	Sulbha

M. E. S. College of Engg. Pane: 411 001.
Department of Computer Engineering
Guest Lecture Attendance (BE)

Topic :

Speaker :

Date: 12/07/18

Roll No.	Name	Sign
1	Aditi Sunil Gaikwad	
2	Anagha Subhedar	
3	Ankam Vaishnavi Ashok	
4	Badhe Ashutosh Ramesh	
5		
6	Chavan Aishwarya Khashaba	
7	Chhajed Namit Ramesh	
8	Chumbalkar Rishabh Vitthal	
9	Cyril Sibi	
10	Deshpande Tushar Shrinivas	
11	Devthane Sudeshana Bharat	
12	Dhamdhare Aditya Rajendra	
13	Gavale Pankaj Ashok	
14	Girniwala Mehnaaz Anwar	
15	Helwade Rushikesh Ratnakar	
16		
17	Hundalekar Priyanka Mohan	
18	Jamdade Yashodhara Anant	
19		
20	Kamble Poonam Prakash	
21		
22		
23	Kapratwar Abhishek Vyanktesh	
24	Karnawat Tanmay Nitin	
25	Karne Priyanka Pandurang	
26	Kasture Pooja Madan	
27	Kenchannavar Shreya Veerappa	
28	Khandagale Nikita Niranjana	
29		
30	Kulkarni Omkar Abhay	
31	Kulkarni Unmesh Giridhar	
32	Kunal Choudhary	
33	Likhite Kanak Sanjit	
34		
35	Londhe Sham Subhash	
36	Mahabare Prasad Sadanand	
37	Mahesh Biswas	
38	Marne Nikhil Sanjay	
39	Meher Ayush Deepak	
40	Mehta Prarthna Ajay	

Roll No.	Name	Sign
41		
42	Pandule Nikita Vishnu	
43	Paris Rohan Toni	
44	Patel Ahad Rafique	
45	Patil Aishwarya Pandurang	
46	Patil Kajal Ashok	
47	Patil Pragati Vijay	
48	Patil Sourabh Gajanan	
49	Payal Khatri	
50	Pingale Rutuja Kailas	
51	Ranade Girija Pradeep	
52		
53	Rathod Neha Ramsing	
54	Raut Makrand Shyamrao	
55	Raut Shubham Sunil	
56	Raval Devangi Mitesh	
57	Sarode Darshana Shantaram	
58	Seth Tanvi Prashantkumar	
59		
60	Sharma Shikha Sushil	
61	Shelake Harshal Kailas	
62	Sherin Samuel	
63		
64	Shirsat Jyoti Shankar	
65	Sumant Arun Ranmale	
66	Swapnil Vishwas Baviskar	
67	Tupone Anurag Sanjay	
68	Uzma Zubair Shaikh	
69	Vanjari Dipali Hirabhai	
70	Vhaval Suyog Suresh	
71	Yadav Ramandra Shivram	
72	Yerwa Rashmi Vinayak	
73	Zaware Aditya Balu	
74	Jadhav Omkar Ashok	
75	Patil Vaibhavi Ulhas	
76	Chavan Sandhya Shahaji	
77	Gawande Madhura Vilasrao	
78	Survase Deepak	
79	Patil Shaunak	

Academic Year: 2020-21

Semester-I

Date: 05/12/2020

Name of activity: Online Guest Lecture on “**Research Trends and Job opportunities in RF/Microwave Industry under Defence Sectors**”.

Objectives:

- 1. To create the awareness about RF/Microwave domain in Defence R&D Sector**
- 2. To motivate the students to select core electronics as their career.**
- 3.To enhance Alumni interaction with current students .**

Name of the Guest Speaker: Dr.Shivraj Rathod (Alumni of E&TC, MESCOE)

Dr S. M. Rathod has received the B.E degree in Electronics & Telecommunication Engineering from MES College of Engineering, University of Pune in 2012. He received both M. Tech and PhD degree in Electronics Engineering from Veermata Jijabai Technological Institute (VJTI), in 2015 and 2019, respectively. Currently, he is an Assistant Manager in Defence R & D Division of Kalyani Centre for Technology and Innovation (KCTI), Bharat Forge Limited (BFL)-Pune. Now, he hold the position of coordinator for “Centre of Excellence in RF & Microwave Technology” at Defence R&D Division of BFL, Pune. He is coordinating the team members at KCTI group for the Indigenous development of various Radar systems for Ministry of Defence under Indian Design, Development and Manufacturing (IDDM) category with Make in India Scheme for Defence production.

He started his presentation by giving introduction of Bharat Forge and its different campuses and their different products .He nicely explained the importance of basic subjects like DSP,DIP,and Electromagnetics,Electronics Design and many more and their applications in Defence industry.He explained the different job opportunities in RF and Microwave area.

Guest Speaker shared his personal experiences,the difficulties faced by him,the efforts taken etc.Dr.Shivraj’s Journey was really motivational .

He also explained about the internship opportunity in BFL,scholarship students can get in BFL.

Target Audience : TE and BE students

No.of Staff Present : 08

No. of Students Present: 70

Day &Date: , 5th December 2020.

Time frame: 11 AM to 1 PM

“Failing to plan is planning to fail”



“Failing to plan is planning to fail”

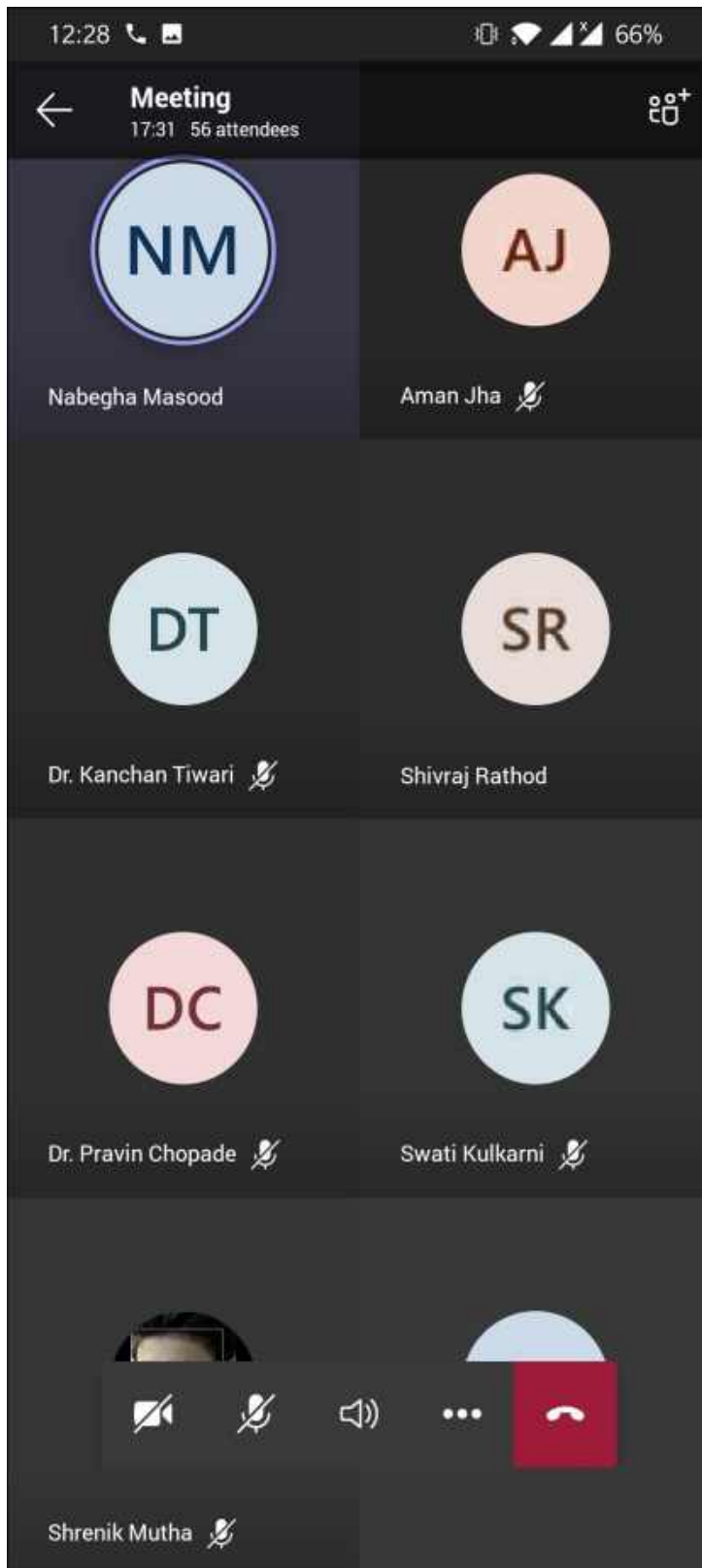

Screenshots of Attendees with Guest Speaker

Faculty Co-ordinators:

Prof. Y. M. Ajgar

HOD

Dr. P. B. Chopade

“Failing to plan is planning to fail”



MES College of Engineering, PUNE-411001
Department of Mechanical Engineering

Ref No.

Date : Saturday 30/10/2021

Activity : **Guest Lecture**

Name of Activity: **Guest Lecture on Power of optimization for Smart product development .**

Objectives of Activity: To prepare students for

- 1 To spread awareness about products Altair university
- 2 To bridge the gap between industry and academia
- 3 To make the students industry ready with the Altair training portal for students
- 4

Target group: SE, TE, BE Mechanical

Number of Present Students: 86

Total Number of targeted group of Students: 350

Resource Person Details

Name of Resource Person: Mr. Ramesha BS
Designation: Sr. Manager-Academic, CSR and Startup Initiative
Organisation / institute: Altair India

Activity Schedule

Duration : 06/10/2021 to 06/10/2021
Time : 02:00 PM
Venue: MS Teams Online

Activity Organised by: Mr. S R Kandharkar

Faculty Associated : Dr. V. N. Chougule

Brief Description of Activity:

The activity was organized to spread awareness about initiatives taken by Altair to bridge gap between Academia and Industry, create a Platform and facilitate interaction. The activity was about making students familiar with products of Altair available for students. So students can learn them online and build their profile by appearing relevant exam of respective course. After successful completion, a profile of student is created and shared with all Global users of Altair. This is a very unique and state of the art facility of Altair



MES College of Engineering, PUNE-411001

Department of Mechanical Engineering

Activity Photographs

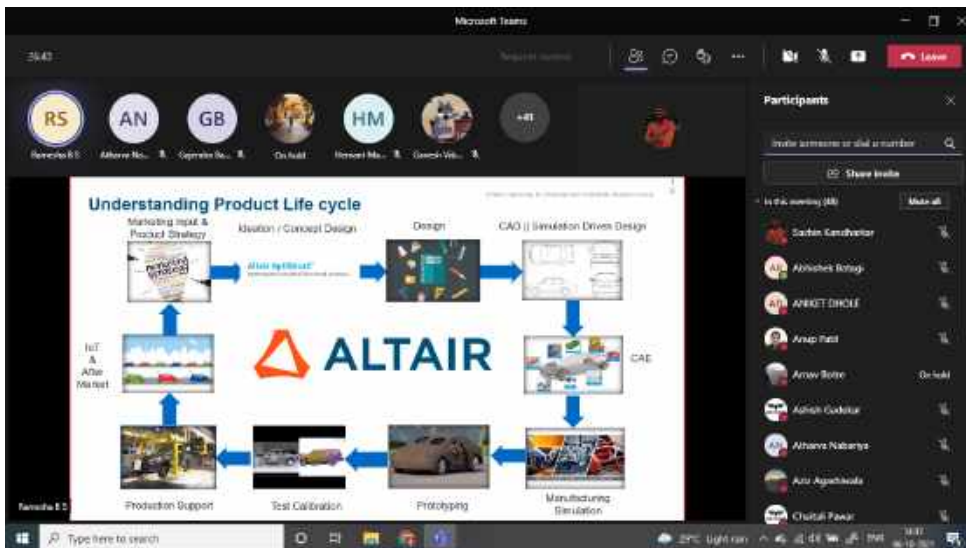
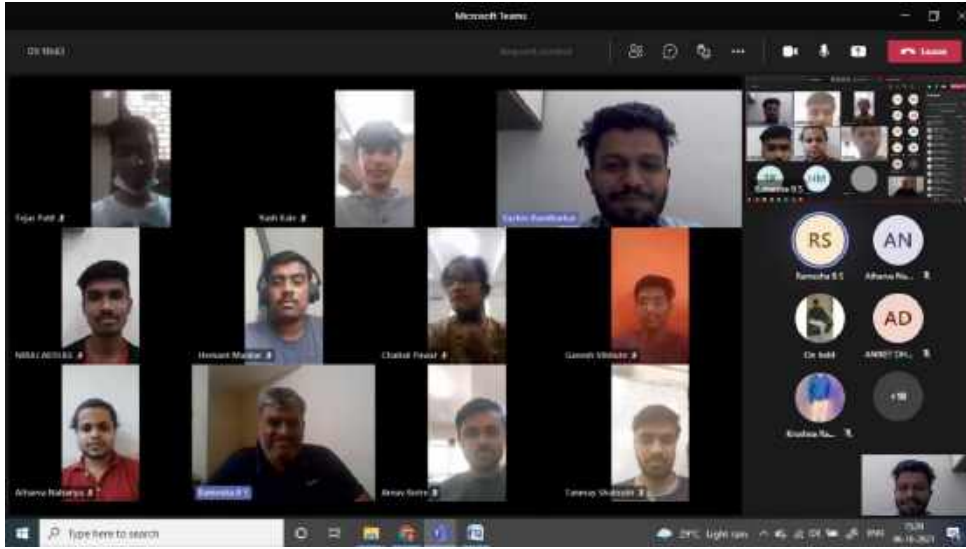



MES College of Engineering, PUNE-411001

Department of Mechanical Engineering

Attendance Certificate





MES College of Engineering, PUNE-411001
Department of Mechanical Engineering

Activity to PO linking: 1: Slight (Low), 2: Moderate (Medium), 3: Substantial (High)

PO1	PO2	PO3	PO4	PO5	PO6	PO7	PO8	PO9	PO10	PO11	PO12	PO13	PO14	PO15
2	2	2	1	3	0	1	2	2	1	1	2	2	3	2

Activity to PO Linking Justification

PO No	Level (1,2,3)	Justification For Activity to PO Linking in Level (1,2,3)
PO1	2	Basic engineering mathematics and principles of engineering are much required for any engineer
PO2	2	Identification and formulation of complex engineering problems using first principles of mathematics, natural sciences, and engineering sciences
PO3	2	Designing the solutions for complex engineering problems and design system components
PO4	1	Use of research-based knowledge and research methods including design of experiments, analysis and interpretation of data
PO5	3	Use of modern engineering tools
PO6	0	
PO7	1	Understand the impact of the engineering solutions in societal and environmental contexts
PO8	2	Apply ethical principles and commit to professional ethics
PO9	2	Function effectively as an individual, and as a member or leader in diverse teams
PO10	1	Communicate effectively on complex engineering activities
PO11	1	Demonstration of knowledge and understanding of the engineering and management principles
PO12	2	life-long learning in the broadest context of technological change
PO13	2	Apply principles of machine design, manufacturing, thermal engineering
PO14	3	Use of modern modeling, simulation techniques and computational tools
PO15	2	Develop practical solutions for mechanical engineering problems

Mr. S R Kandharkar
 Activity Organiser

HoD
 Mechanical Engg. Dept.



MES College of Engineering, PUNE-411001
Department of Mechanical Engineering

ATTENDANCE REPORT

Abhishek Batagi	10/6/2021, 2:29:34 PM	10/6/2021, 33m 11s	m21_abhis Presenter
Abhishek Batagi	10/6/2021, 3:14:48 PM	10/6/2021, 15s	m21_abhis Presenter
NIRAJ ADSULE	10/6/2021, 2:31:42 PM	10/6/2021, 1m 30s	m22_niraj. Presenter
NIRAJ ADSULE	10/6/2021, 2:34:44 PM	10/6/2021, 58m 19s	m22_niraj. Presenter
Tohafik Datarange	10/6/2021, 2:32:58 PM	10/6/2021, 6m 23s	m22_tohaf Presenter
Rohit Patole	10/6/2021, 2:33:08 PM	10/6/2021, 49s	m31_rohit. Presenter
Vishal Kalotra	10/6/2021, 2:33:10 PM	10/6/2021, 3m 39s	m22_visha Presenter
Vishal Kalotra	10/6/2021, 3:01:52 PM	10/6/2021, 10m 46s	m22_visha Presenter
Pratik Ghugarkar	10/6/2021, 2:33:50 PM	10/6/2021, 3m 8s	m32_prati Presenter
Yash Kale	10/6/2021, 2:34:04 PM	10/6/2021, 8m 47s	m21_yash. Presenter
Yash Kale	10/6/2021, 2:45:55 PM	10/6/2021, 47m 11s	m21_yash. Presenter
Audumber Jagtap	10/6/2021, 2:41:15 PM	10/6/2021, 5m 55s	m12_audu Presenter
Audumber Jagtap	10/6/2021, 2:48:19 PM	10/6/2021, 6m 54s	m12_audu Presenter
Manas Ghodke	10/6/2021, 2:42:16 PM	10/6/2021, 5m 8s	m21_mana Presenter
Shravan Garad	10/6/2021, 2:57:36 PM	10/6/2021, 50s	m22_shrav Presenter
Bhagyesh Patil	10/6/2021, 2:59:34 PM	10/6/2021, 14m 10s	bhagyesh.ç Presenter
Bhagyesh Patil	10/6/2021, 3:14:46 PM	10/6/2021, 18m 38s	bhagyesh.ç Presenter
Sneha Wanve	10/6/2021, 3:00:07 PM	10/6/2021, 16m 54s	Sneha19@ Presenter
m31_shardul.ashtekar_2021	10/6/2021, 3:02:30 PM	10/6/2021, 29s	m31_shard Presenter
Vaibhav Ghati	10/6/2021, 3:04:19 PM	10/6/2021, 6m 51s	m31_vaibh Presenter
Ketaki Mahajan	10/6/2021, 3:06:22 PM	10/6/2021, 36s	m32_ketak Presenter
Vijay Pawar	10/6/2021, 3:30:09 PM	10/6/2021, 1m 28s	m31_vijay. Presenter

m31_ravindra.more_2021	10/6/2021, 2:21:20 PM	10/6/2021, 7m	m31_ravin Presenter
Swamini Pachankar	10/6/2021, 2:21:23 PM	10/6/2021, 44m 34s	swamini.pç Presenter
Momin Musharraf Shaikh Junaid	10/6/2021, 2:21:26 PM	10/6/2021, 38m 57s	m32_mom Presenter
Prasad Khachane	10/6/2021, 2:22:08 PM	10/6/2021, 1m 27s	m31_prasa Presenter
Anushka Patil	10/6/2021, 2:22:11 PM	10/6/2021, 39s	m31_anusi Presenter
Omkar Deshpande	10/6/2021, 2:22:15 PM	10/6/2021, 13m 8s	m22_omka Presenter
Ganesh Kaimani	10/6/2021, 2:22:28 PM	10/6/2021, 23m 9s	m31_gane: Presenter
Sharon James	10/6/2021, 2:22:51 PM	10/6/2021, 24m 41s	m31_sharc Presenter
Chaitali Pawar	10/6/2021, 2:23:07 PM	10/6/2021, 1h 10m	Chaitalipaw Presenter
Arnav Botre	10/6/2021, 2:23:19 PM	10/6/2021, 1h 9m	arnavbotre Presenter
Shravani Naidu	10/6/2021, 2:23:42 PM	10/6/2021, 29m 25s	c11_shrava Presenter
Shravani Naidu	10/6/2021, 3:29:30 PM	10/6/2021, 4m 8s	c11_shrava: Presenter
Tapasya Patil	10/6/2021, 2:23:45 PM	10/6/2021, 15m 14s	m22_tapas Presenter
Tapasya Patil	10/6/2021, 2:42:12 PM	10/6/2021, 48m 27s	m22_tapas Presenter
Swapnil Chougule	10/6/2021, 2:23:52 PM	10/6/2021, 1h 9m	swapnil.chi Presenter
Manas Bagade	10/6/2021, 2:24:23 PM	10/6/2021, 7m 6s	m32_mana Presenter
Kuldeep Mahajan	10/6/2021, 2:24:41 PM	10/6/2021, 52s	kamahajan Presenter
Vaishnavi Kulkarni	10/6/2021, 2:24:49 PM	10/6/2021, 56m 15s	m22_vaish Presenter
Pranali Rokade	10/6/2021, 2:25:23 PM	10/6/2021, 1m 59s	m32_pran: Presenter
Mohammad Farhan Shaikh	10/6/2021, 2:25:25 PM	10/6/2021, 41m 12s	m31_mohi: Presenter
Ritesh Banarase	10/6/2021, 2:25:28 PM	10/6/2021, 37m 42s	m21_rites! Presenter
Shreya Londhe	10/6/2021, 2:25:41 PM	10/6/2021, 21s	m31_shrey Presenter
Anup Patil	10/6/2021, 2:26:36 PM	10/6/2021, 22m 54s	Anup.Patil! Presenter
ANIL BHURKE	10/6/2021, 2:26:53 PM	10/6/2021, 20s	m31_anil.b Presenter
Rohan Chougule	10/6/2021, 2:27:30 PM	10/6/2021, 20m 30s	e11_rohan Presenter
Tushar Tikhe	10/6/2021, 2:29:07 PM	10/6/2021, 19m 47s	c11_tushar Presenter
Abhishek Batagi	10/6/2021, 2:29:34 PM	10/6/2021, 33m 11s	m21_abhis Presenter
Abhishek Batagi	10/6/2021, 3:14:48 PM	10/6/2021, 15s	m21_abhis Presenter
NIRAJ ADSULE	10/6/2021, 2:31:42 PM	10/6/2021, 1m 30s	m22_niraj. Presenter
NIRAJ ADSULE	10/6/2021, 2:34:44 PM	10/6/2021, 58m 19s	m22_niraj. Presenter
Tohafik Datarange	10/6/2021, 2:32:58 PM	10/6/2021, 6m 23s	m22_tohaf Presenter
Rohit Patole	10/6/2021, 2:33:08 PM	10/6/2021, 49s	m31_rohit. Presenter



MES College of Engineering, PUNE-411001

Department of Mechanical Engineering

Varsha Gaikwad	10/6/2021, 3:27:00 PM	10/6/2021, 6m 38s	m21_varsh Presenter
Satyam Somvarshi	10/6/2021, 2:15:44 PM	10/6/2021, 1h 2m	m21_satya Presenter
Rahul Vaidya	10/6/2021, 2:15:59 PM	10/6/2021, 1h 17m	m22_rahul Presenter
Tanmay Shalrushi	10/6/2021, 2:16:26 PM	10/6/2021, 1h 16m	m21_tanm Presenter
Tejas Patil	10/6/2021, 2:16:27 PM	10/6/2021, 1h 16m	m22_tejas. Presenter
PRITHVIRAJ ABITKAR	10/6/2021, 2:16:31 PM	10/6/2021, 50m 3s	m22_prith Presenter
PRITHVIRAJ ABITKAR	10/6/2021, 3:29:12 PM	10/6/2021, 2m 13s	m22_prith Presenter
Sanket Kasar	10/6/2021, 2:16:52 PM	10/6/2021, 3m 59s	m31_sankt Presenter
Samruddhi Patil	10/6/2021, 2:16:58 PM	10/6/2021, 21s	m32_samr Presenter
SURAJ WAGH	10/6/2021, 2:17:00 PM	10/6/2021, 7s	m31_suraj. Presenter
SURAJ WAGH	10/6/2021, 3:03:05 PM	10/6/2021, 9m 21s	m31_suraj. Presenter
m32_maneesh.pendem_2021	10/6/2021, 2:17:00 PM	10/6/2021, 28m 49s	m32_mane Presenter
Yash Agrawal	10/6/2021, 2:17:06 PM	10/6/2021, 25s	m31_yash. Presenter
ANIKET DHOLE	10/6/2021, 2:17:14 PM	10/6/2021, 1h 14m	m31_anike Presenter
Aziz Agashiwala	10/6/2021, 2:17:32 PM	10/6/2021, 40m 3s	m31_aziz.a Presenter
Nikhil Patil	10/6/2021, 2:17:42 PM	10/6/2021, 34m 47s	m31_nikhil Presenter
Nikhil Shinde	10/6/2021, 2:17:43 PM	10/6/2021, 11s	m32_nikhil Presenter
Vedant Mophare	10/6/2021, 2:18:17 PM	10/6/2021, 21m 7s	m22_vedat Presenter
Vedant Mophare	10/6/2021, 2:40:37 PM	10/6/2021, 16m 45s	m22_vedat Presenter
Pranav Bharate	10/6/2021, 2:18:18 PM	10/6/2021, 19m 19s	m22_pranv Presenter
m31_advay.todsam_2021	10/6/2021, 2:18:21 PM	10/6/2021, 48s	m31_advaj Presenter
Krushna Rashinkar	10/6/2021, 2:18:29 PM	10/6/2021, 1h 14m	m22_krush Presenter
Shreeharsh Parab	10/6/2021, 2:19:03 PM	10/6/2021, 8m 24s	m32_shree Presenter
Suraj Amrutkar	10/6/2021, 2:19:24 PM	10/6/2021, 6m 13s	m31_suraj. Presenter
Pratik Deshmukh	10/6/2021, 2:19:31 PM	10/6/2021, 52m 6s	m21_pratil Presenter
Yash Chaudhari	10/6/2021, 2:19:51 PM	10/6/2021, 21m 34s	m31_yash. Presenter
Shreyash Patil	10/6/2021, 2:19:58 PM	10/6/2021, 30m 12s	m21_shrey Presenter
Ankit Patil	10/6/2021, 2:20:13 PM	10/6/2021, 33s	m22_ankit Presenter
Pravin Chandole	10/6/2021, 2:20:20 PM	10/6/2021, 27m 41s	m31_pravi Presenter
Kanishka Pawar	10/6/2021, 2:20:35 PM	10/6/2021, 1h 12m	kanishka.p Presenter
Mathew S George	10/6/2021, 2:20:54 PM	10/6/2021, 1h 8m	m21_math Presenter
Ishan Jedhav	10/6/2021, 2:21:12 PM	10/6/2021, 2m 52s	m22_ishan Presenter

Meeting Summary

Total Number of Participants

86

Meeting Title

Power of optimization for Smart product development: MES College of Engineering, Pune, MH

Meeting Start Time

10/6/2021, 2:10:43 PM

Meeting End Time

10/6/2021, 3:33:44 PM

Meeting Id

4fc57a09-f55e-4a82-907d-f232f967524f

Full Name	Join Time	Leave Time	Duration	Email (user Role)
Ramesha B S	10/6/2021, 2:10:43 PM	10/6/2021, 1h 22m		rambs@asi Organizer
Sachin Kandharkar	10/6/2021, 2:10:51 PM	10/6/2021, 1h 22m		sachin.kan Presenter
Atharva Nabarlya	10/6/2021, 2:10:52 PM	10/6/2021, 1h 22m		m21_athar Presenter
VAIBHAV NAGAPURE	10/6/2021, 2:12:13 PM	10/6/2021, 5s		m21_vaibh Presenter
VAIBHAV NAGAPURE	10/6/2021, 2:13:39 PM	10/6/2021, 22s		m21_vaibh Presenter
Niyati Shendge	10/6/2021, 2:12:18 PM	10/6/2021, 6s		m21_niyat Presenter
Tushar Ghatge	10/6/2021, 2:12:26 PM	10/6/2021, 1s		m21_tusha Presenter
Gargi Kulkarni	10/6/2021, 2:12:33 PM	10/6/2021, 13m 33s		m21_gargi. Presenter
Gargi Kulkarni	10/6/2021, 2:45:06 PM	10/6/2021, 12m 23s		m21_gargi. Presenter
Gajendra Bagi	10/6/2021, 2:12:34 PM	10/6/2021, 1h 8m		m21_gajen Presenter
Rayyan Shaikh	10/6/2021, 2:13:00 PM	10/6/2021, 18s		m22_rayya Presenter
Jayesh Sonawane	10/6/2021, 2:13:14 PM	10/6/2021, 25m 31s		m21_jayes Presenter
Shubham Thite	10/6/2021, 2:13:26 PM	10/6/2021, 3s		m21_shubl Presenter
Shubham Thite	10/6/2021, 2:16:41 PM	10/6/2021, 1h 16m		m21_shubl Presenter
Kunal Padgelwar	10/6/2021, 2:13:31 PM	10/6/2021, 15m 21s		m21_kunal Presenter
Hemant Mankar	10/6/2021, 2:14:00 PM	10/6/2021, 1h 18m		c11_hemar Presenter
Ganesh Vibhute	10/6/2021, 2:14:41 PM	10/6/2021, 1h 18m		m12_gane Presenter
Aaron Moraes	10/6/2021, 2:14:48 PM	10/6/2021, 22m 39s		m12_aaror Presenter
Jay Sawant	10/6/2021, 2:14:57 PM	10/6/2021, 1h 18m		m21_jay. Presenter
Ashish Gadekar	10/6/2021, 2:15:19 PM	10/6/2021, 9m 8s		ashish@mx Presenter
Ashish Gadekar	10/6/2021, 2:27:22 PM	10/6/2021, 1h 5m		ashish@mx Presenter
Varsha Gaikwad	10/6/2021, 2:15:39 PM	10/6/2021, 49m 59s		m21_varsh Presenter



MES College of Engineering, PUNE-411001
Department of Mechanical Engineering

CERTIFICATE

Saturday 30/10/2021

This is to certify that **Mr. S R Kandharkar & Dr. V. N. Chougule** has completed the **Guest Lecture on Power of optimization for Smart product development** activity from **06/10/2021 to 06/10/2021**.

Duty leave can be **Considered / Not Considered** for above faculties from **06/10/2021 to 06/10/2021**

HoD

Mechanical Engineering

M.E.S. College of Engineering
Department of Computer Engineering
BE Project List AY 2018-19
Guide Allocation

Group ID	Project Group Members	Project Topic	Guide Name	Sponsorship
1	Kshitij Agarwal	Crop Recommendation System using A.I	Prof.G.S.Pole	In-House
	Shubham Pathrikar			
	Pranjali Gurav			
2	Ramanda Yadav	Gesture Based wireless equipment control	Prof.M.Shinde	In-House
	Sherin Samual			
	Omkar Jadhav			
	Sumant Ranmale			
3	Deepali Jawale	Efficient pattern matching algorithm in IDS	Prof.A.P.Kale	In-House
	Aayushi Kochar			
	Sayali Khomane			
	Sharvari Kamble			
4	Abhishek Shrivastava	Smart health predictioning	Mrs. N.I.Ujloomwale	In-House
	Tushar Shinde			
	Vithal Waghmode			
	Ankit Lokhande			
5	Prasad Mahabare	Secure browsing from phishing attacks using ML	Prof.R.A.Khan	In-House
	Kanak Likhite			
	Makarand Raut			
	Swapnil Baviskar			
6	Sahil Shitole	Devanagari Numeral recognition using ML Algorithms	Prof.S.P.Deore	In-House
	Uday Sawant			
	Rameez Parkar			
7	Tanvi Seth	A cross platform application using phone gap	Prof.S.R.Balwan	In-House
	Uzma Shaikh			
	Rohan Paris			
8	Yogita Garje	Disease prediction system using decision tree	Prof.B.K.Bodkhe	In-House
	Jasmine Mulla			
	Shah Afreen			
	Madhuri Wavhal			
9	Shweta Kolhe	Query Time Optimization using Hungarian Algorithm	Prof.R.M.Wahul	In-House
	Ruchi Shinde			
	Steffy Dias			
	Richa Chaudhari			
10	Darshna Sarode	Garbage Monitoring System	Prof.S.Keshari	In-House
	Sudeshna Devthane			
	Aishwaraya Patil			
	Neha Rathod			

11	Harshda Yadav	Securing the data from false data injection	Prof.S.Keshari	In-House
	Rajnandini Satav			
	Akshita More			
12	Shubham Kapadnis	Port level security	Prof.S.P.Khedkar	Sponored DRDO
	Sandhya Chavan			
	Rutuja Kauthale			
	Karan Shah			
13	Yogini Ghodke	Hide old seek	Prof.S.H.Pathan	In-House
	Manali Jagtap			
	Ibtesham Shaikh			
14	Bhavesh Patil	Smart TV	Prof S Khade	In-House
	Sushil Jagtap			
	Nitin Hirve			
	Tushar Pandhare			
15	Rushikesh Rathod	Vehical Sefty system	Prof G B Deshmukh	In-House
	Nishant Chavan			
	Vaishnavi Kamthe			
	Sushant Bhalerao			
16	Ayush Meher	Smart mirror	Prof.S.H.Pathan	In-House
	Pankaj Gavale			
17	Jennifer Fernandes	Handwritten Devanagari words recognition System	Prof.S.P.Deore	In-House
	Gouri Kolte			
	Samira Nikharge			
	Prashant			
	Vishwakarma			
18	Rashmi Yerwa	Chatbot for medical assistance	Prof.G.S.Pole	In-House
	Payal Khatri			
	Mehnaaz Girniwala			
	Cyril Sibi			
19	Omkar Kulkarni	Indoor assistance system for visual impaired people.	Dr.Mrs.N.F.Shaikh	In-House
	Ashutosh Badhe			
	Mahesh Biswas			
	Shubham Raut			
20	Hitesh Nimade	Secure file storage on cloud using hybrid cryptography	Prof.S.P.Khedkar	In-House
	Aditya Poduval			
	Rohan Nikam			
	Abijeet Doke			

21	Bhagyashri k. sarda	Smart helmet for accident detection using sensors	Prof.N.L.Chourasiya	In-House
	Diksha Adsul			
	Akshay Jain			
22	Jitender Choudhary	Tpo portal with data analytic & smart contracts	Dr. Mrs.S.K.Wagh	Sponsored (Sapours Tech.)
	Dheeraj Agrawal			
	Laxmikant Hire			
	Kapil Barure			
23	Devika Khandagale	Crop recommendation based on Microclimatic Conditions	Prof.N.L.Chourasiya	In-House
	Nida Shaikh			
	Purvi Modi			
	Sayali Pawar			
24	Riddhi Sanghvi	wirless door locking system	Prof.S.B.Shinde	In-House
	Adesh Pardeshi			
	Amit Vani			
	Soham Bhoj			
25	Subhara Gurav	Fake news detection	Prof.S.A.Hirve	In-House
	Supriya Shinde			
	Swati Sase			
	Prachi Wabale			
26	Pratiksha Ovhal	twitter data analysis for business operation and risk management	Prof.S.A.Hirve	In-House
	Hrutuja Narawade			
	Shruthi Mane			
27	Shraddha Mahashikhare	social Q and A:: An online social network based questions and answers system	Mrs. N.I.Ujloomwale	In-House
	Swarali Choughule			
	Yogita Dhanwate			
	Sulubha Virkar			
28	Tushar Deshpande	Predection of heart diseases using machine learning	Prof S Khade	In-House
	Unmesh Kulkarni			
	Anagha Subhedar			
	Kunal Choudhary			
29	Anuragh Tupone	Bicycle reallocation using data analysis	Prof. S Pisey	In-House
	Harshal Shelke			
	Nikhil Marme			
	Sourabh Patil			
30	Nikita Solunke	Automated technical answer grading system using machine learning	Prof.A.D.Dhawale	In-House
	Sushila Choudhary			
	shivam Moray			

31	Adnan Shaikh	Context based Grammar Checking and Correction	Prof.A.D.Dhawale	In-House
	Gaurav Salode			
	Nuved Munshi			
	Rutvik Nata			
32	Tejashwani Bhukan	Voice based email system	Prof.S.S.Raskar	In-House
	Twinkle Kudale			
	Nirmal Gadekar			
	Kudale Jyoti			
33	Aditya Zaware	Sentiment analysis using big data	Prof. S Pisey	In-House
	Tanmay Karnawat			
34	Girija Ranade	Secure data transmission over cloud using load balancing and deduplication	Prof.M.A.Malwade	In-House
	Prarthana Meheta			
	Nikita Pandule			
	Shreya K			
35	Vaishnavi Ankham	Real time text reader	Dr.J.R.Pansare	In-House
	Aditi Gaikwad			
	Priyanka Kame			
	Shikha Sharma			
36	Swapnil Bhambure	Predictive maintaince for automobile using AI & ML	Dr.Mrs.N.F.Shaikh	In-House
	Prakash Patel			
	Pallavi Jain			
	Yashraj Sen			
37	Manjusha Sarang	Smart Pantry System	Ms.D.D.Ahir	In-House
	Pallavi Kolapkar			
	Shweta Jadhav			
	Somesh Pathak			
38	prajkta patil	Multi-attacks Detection in Distibuted system using Machine Learning	Prof.S.R.Khonde	Sponsored (Sapours Tech.)
	sharwari kulkarni			
	Cristal Lobo			
	Tanaz Bagwan			
39	Rishabh chumbalkar	Municipal corporation system using block chain	Ms.D.D.Ahir	In-House
	pooja kasture			
	Rutuja pingale			
	pragati patil			
40	Aishwarya Chavan	Author Identification using Data Mining Techniques	Prof.M.Shinde	In-House
	yashodhara Jamdade			
	Priyanka Hundaleker			
	Poonam Kamble			

41	pratiksha s kulkarni	facial emotion extract&recognition	Prof.N.Zaman	In-House
	Ankita m bhosale			
	Ashwini Pawar			
	Mansi m kshirsagar			
42	Gaurav Dhandle	smart table	Prof.G.B.Aochar	In-House
	Ankita khareshiya			
	Ghazala Mirani			
43	Aakash Jadhav	Indoor positioning system	Mrs.P.R.Rajmane	In-House
	Vipul Jadhav			
	Hrishikesh Borkar			
	Arjun Shinde			
44	Aditya ujeniya	A Hybrid approach towards distributed Intrusion Detection System	Prof.S.R.Khonde	Sponsored (Sapours Tech.)
	shubham shingade			
	sagar sonawane			
	Rahul pawar			
45	Shivani Thakar	Diamond clarity Assessment	Prof.G.B.Aochar	In-House
	Dheeraj Tambare			
	Cyril Jose			
	urmeez panthaki			
46	Shikha Jaiswal	smart chair	Prof.S.S.Raskar	In-House
	Priyanka Lokhande			
	Pooja Rade			
	Rutuja Shitole			
47	Akshay bhat	mixed Reality using Microsoft	Prof.S.B.Shinde	In-House
	Rishika Godgul			
	Asawari paste			
	Harshal Tathe			
48	Madhura gawande	medibot medical assistance agent uing NLP	Prof.N.Zaman	In-House
	Tazeen Khan			
	Vaibhavi Patil			
	Mayuri Patil			
49	Rushabh Nichat	Analysis sentiments in one go	Ms.P.R.Rajmane	In-House
	Pankaj Gandhi			
	Aniket Nagdekar			
	Vedant Ghag			
50	kapratar Abhishek	Predicting stock market using Big data	Prof A. S. Kamble	In-House
	patel Ahad R			
	Helwate Rushikesh			
	Nikita Khandagale			

51	Jyoti shirsat	Data privacy preservation throgh crypMDB	Prof.B.K.Bodkhe	In-House
	Dipali Vanjari			
	kajal patil			
	Devangi Rawal			
52	Rahul Deshmukh	Estimating engagement or disenengagement of audience while watching a video or movie	Prof.A.P.Kale	In-House
	Akhilesh Kalebare			
	Shaunk Patil			
	Rahul Bhagia			
53	Anurag Gajare	Secure duplication detection technique in cloud	Prof S.R.Balwan	In-House
	Pratik Ghare			
	Pranil Bari			
	Deepak Bhageshwar			
54	Akshay Titar	Music Reccomdentation System	Prof.M.A.Malwade	In-House
	Shivsagar Maykar			
	suraj Purohit			
	Nayan Bhahirame			
55	Namit chhajer	Virtual collabarity cryptography schemes	Prof.G.B.Deshmukh	In-House
	aditya Dhamdhare			
	Ashawini Katre			
	Deepak Survase			
	BE project Co-ordinators	<i>Handwritten signature</i>	HOD	<i>Handwritten signature</i>



MES College of Engineering, PUNE-411001
Department of Mechanical Engineering

Ref No.

Date : **Sunday 19/07/2020**

Activity : **Guest Lecture**

Name of Activity: **One Week Student skill Development Workshop 2020 (SSDW 2020) : Latex.**

Objectives of Activity: To prepare students for

- 1 To develop skill of students which then can use to improve their performance
- 2 To teach them Document writing Tool used in academia
- 3 To educate them on Report writing using Latex
- 4

Target group: SE, TE, BE Mechanical

Number of Present Students: 40

Total Number of targeted group of Students: 160

Resource Person Details

Name of Resource Person: Prof. (Dr.) V. N. Chougule, Prof. A. R. Patil, Prof. S. M. Narsale and Spoken Tutorial Videos

Designation: Faculty

Organisation / institute: M. E. S. College of Engineering, Pune

Activity Schedule

Duration : 13/07/2020 to 20/07/2020

Time : 11:00 AM

Venue: Web Based Training Program

Activity Organised by: Mr. A. R. Patil

Faculty Associated : Dr. V. N. Chougule

Brief Description of Activity:

Activity was conducted for one Week, Each day on different modules of Latex. First Day started with address video message by Prof. Sampada Joshi (COO, M E S) and live web session by Prof. (Dr.) V. N. Chougule (HoD, Mechanical Dept., MESCOE). Afterward hands on Session by difference resource person along with Training videos by Spoken-tutorial were conducted. Every day assignment were given and their doubts were discussed in afternoon session at 4.00 pm This activity is concluded with exam and passing students were given certificates.



Activity Photographs





MES College of Engineering, PUNE-411001
Department of Mechanical Engineering



Attendance Certificate

Web Based Program
Hence attendance is in
Web Form



MES College of Engineering, PUNE-411001
Department of Mechanical Engineering

Activity to PO linking: 1: Slight (Low), 2: Moderate (Medium), 3: Substantial (High)

PO1	PO2	PO3	PO4	PO5	PO6	PO7	PO8	PO9	PO10	PO11	PO12	PO13	PO14	PO15
0	0	0	0	2	0	0	0	0	2	0	0	0	0	0

Activity to PO Linking Justification

PO No	Level (1,2,3)	Justification For Activity to PO Linking in Level (1,2,3)
PO1	0	
PO2	0	
PO3	0	
PO4	0	
PO5	2	Student educated about use of Latex in document writing
PO6	0	
PO7	0	
PO8	0	
PO9	0	
PO10	2	Students learned how to prepare project report, PPT and letter using Latex
PO11	0	
PO12	0	
PO13	0	
PO14	0	
PO15	0	

Mr. A. R. Patil
Activity Organiser

HoD
Mechanical Engg. Dept.



ATTENDANCE REPORT

Web Based Program
Hence attendance is in
Web Form



MES College of Engineering, PUNE-411001
Department of Mechanical Engineering

CERTIFICATE

Sunday 19/07/2020

This is to certify that **Mr. A. R. Patil & Dr. V. N. Chougule** has completed the **One Week Student skill Development Workshop 2020 (SSDW 2020) : Latex activity** from **13/07/2020 to 20/07/2020**.

Duty leave can be **Considered / Not Considered** for above faculties from **13/07/2020 to 20/07/2020**

HoD

Mechanical Engineering

Academic Year: 2020-21

Semester-II

Date: 16/1/2021

Name of activity: Online on “Linux for Embedded Engineer “.

Objectives:

1. To gain a strong foundation in Linux from scratch.
2. To help students master important Linux concepts such as Linux installations, Packages, Architecture, File System .
3. To enhance Alumni interaction with current students.

Name of the Guest Speaker: Mr.Tejas Vasekar (Alumni of E&TC, MESCOE)

Mr.Tejas Vasekar has received the B.E degree in Electronics & Telecommunication Engineering from MES College of Engineering, University of Pune in 2017.Currently, he is.

Working as Firmware Engineer at AMS semiconductor Hyderabad .He has 2.5 years of experience in Firmware Engineering ,worked on multiple HW platform .The topics covered during the session are as follows .

1. Linux introduction
 - Distros
 - File structure
2. Linux basics
 - Directory structure of /
 - App installation
 - App finding
 - Open source alternatives
 - Gaming
3. arm-none-eabi setup
 - Setting up different cross compilers.
4. Make file introduction
5. Make file example analysis
6. Make file project
7. Git introduction
8. Git basics
9. Git example

Guest Speaker shared his personal experiences,the difficulties faced by him,the efforts taken etc.

Target Audience : SE ,TE and BE students

No. of Students Present: 77

Day &Date: , Saturday ,16 January 2021

“Failing to plan is planning to fail”

Time frame: 11 AM to 5 PM .



Screenshots of Attendees with Guest Speaker

Faculty Co-ordinators:

Prof. Y. M. Ajar Prof Priyanka Bagul

HOD

Dr. P. B. Chopade

“Failing to plan is planning to fail”



**Modern Education Society's
College of Engineering, Pune
&
Board of Students' Development
Savitribai Phule Pune University, Pune**



Name of activity: " Four days workshop on Ideation and Entrepreneurship in IOT", on 8th Feb, 9th Feb and 7th March, 8th March 2020

This scheme is introduced by the Board of Students' development, Savitribai Phule Pune University under workshop/seminar/other activity and is jointly organized by Department of Electronics and Telecommunication Engineering, Modern Education Society's College of Engineering, Pune, This program is organized for E&TC Engineering students.

About Speaker

1. Mr. Aniket Vykos
2. Mr. Vishal Deshpande
3. Mr. Abhijeet Ankush

Topics Covered

- Introduction to basics of IOT
- Bottom up approach for IOT
- Basic Build Blocks of IOT
- Sensors, Microcontroller, Gateway/Access Point, Cloud, Client
- Sensor types, Microcontroller, Sensor Interfacing, Data Acquisition.
- Gateway, Data Packing and publishing to server.
- IP Protocols, RF communications between microcontrollers and gateway.
- Cloud Platform, Data Monitoring, Data Analysis.
- Client, Controlling connected devices.

Objectives:

1. To expose students to the latest technology and innovations.
2. To generate breakthrough ideas and transform them into revolutionary innovations in the various fields using IOT.

Outcomes:

Students will be able

1. To implement knowledge of IOT
2. To apply IOT concepts to different problems.

PEO s satisfied and POs achieved

PEO s: 1,5

POs: 3,5,12

PSOs: 1,3

Target group: E&TC Engineering students.

No. of students Present: 39

Duration: Four days, 8th Feb, 9th Feb and 7th March, 8th March 2020

Venue:

Time frame: 09.00 am -05.00pm (6 Hr)

Budget Rs: 45000/-

Snaps of the events-





Inauguration and felicitation of Resource Person



Students Listening to Mr.Aniket WayKos





Co-ordinator
Yogita Ajar
Dr.A.A.Keste

HOD
Dr .P.B.Chopade

Principal

A

REPORT ON

“JHANKAAR - 2018”

वसुधैव कुटुम्बकम्



MODERN EDUCATION SOCIETY'S
COLLEGE OF ENGINEERING, PUNE-01
Accredited by NAAC with “A” Grade

Vision of Institution:

- To Groom- Motivated, Environment friendly, Self-esteemed, Creative and Oriented Engineers.

Mission of Institution:

To Develop Industry Oriented Manpower to accept the challenges of Globalization by,

- Promoting Value Education through motivated trained faculty.
- Maintaining conducive environment for education at affordable cost.
- Promoting Industry Institute interaction.
- Involving Alumni.

Goals and Objectives of the Institution:

1. To ensure **all-round development** of students by providing co-curricular, extra-curricular and entrepreneurship skills.
2. To imbibe research culture in students and faculty by providing state-of-the-art research facilities and Industry Institute interaction.
3. To inculcate moral integrity in students and make them **socially responsible,** good human beings.
4. To develop **leadership qualities** and the ability to work as a team among students by encouraging participation in various activities.

INDEX

1. Cultural Activities Team (CAT) OF MESCOE.....	01
2. Rules for Events	04
3. Sub-Committees.....	05
4. List of various Events & Activities.....	06
5. Jhankaar 2018 Budget	16
6. Police Permission & Cultural hall Booking	21
7. Schedule of cultural week.....	25
8. Jhankaar 2018 Schedule.....	26
9. Activity Reports:	
a. Rangoli.....	36
b. Mehendi	39
c. Drawing & Painting	42
d. Photography	44
e. Stage control.....	48
f. Staff Antakshari.....	66
g. Mr& Miss MESCOE	68
h. Treasure Hunt	73
i. Art Gallery.....	76
j. Light, Smoke And Sound Committee	80
k. Inauguration/Felicitation	82
l. Drama Committee	85
m. Fashion Show	88
n. Singing Committee	90
o. Dance Committee	95
p. Anchoring Committee.....	100
q. Stage Decoration	103
r. Fun Fair	105
s. Prize Distribution Ceremony (Toppers).....	110
t. Day's Committee	115
u. MESCOE youth inspirer	119
v. Publicity & Web Management.....	122
w. Cultural Events Prize Distribution.....	123

x. Video Shooting.....	126
y. Discipline.....	129
z. Documentary and Short Film Competition.....	131
aa. MESCOE talent.....	135
10.Expenditure	139
11.Report Generation Committee Views.....	144
12.Report and suggestions from student core committee.....	145

Cultural Activities Team (CAT) OF MESCOE

Introduction

Cultural activities are an integral part of students' college life. Students participate in the cultural activities for a wide variety of reasons: for enjoyment and entertainment, for personal growth and development, as a means of expression, to learn new skills, to meet new people and to pass on the cultural traditions. M.E.S. College of Engineering has a rich heritage of nurturing, nourishing and showcasing talents in the fields of cultural, literary and fine arts. To showcase student's talents college gives a platform of **JHANKAAR** (Annual Gathering).

Structure of CAT

MESCOE CAT is headed by Principal, Registrar, Cultural Head, Student General Secretary, Student CAT Secretaries, Cultural Activity Committee, aided by the Heads of various departments, the student presidents of different clubs and the student volunteers.

Objectives of CAT

- The main objective of the CAT is to bring out the various talents of the students.
- To provide a platform for budding artists and musicians
- To inculcate team spirit and to account for overall personality development of students.

Motivation to Students

- MESCOE CAT motivates students by giving full support (financially and academically) for participation in national and international events.
- Students are encouraged to participate in the activities by providing the necessary instruments and required facilities.

Cultural Activities Team (CAT) OF MESCOE 2017-18

Post	Name
Chairman	Dr. A. A. Keste
Vice- Chairman	Dr. V. N. Raibhole
Member	Mr. S. S. Ingole
Cultural Head	Prof. P. N. Kota (E&TC) Prof. S. R. Kandharkar(MECH) Mr. Prasad. P. Bhoge (Physical Director)
Department Staff Co-ordinators	Prof. L.K. Guttadar (E&TC) Prof. P. M. Ambure (E&TC)
	Prof. S. R. Balwan (COMP) Prof. S. A. Salve(COMP)
	Prof. A. A. Patil(MECH) Prof .C. B. Meshram (MECH)
Student Cultural Secretary	Mr. Shekhar Suryawanshi
Student Core-Committee	Ms. Komal Walke(DCS-MECH)
	Ms. Priyanka Dhivar
	Mr. Niraj Bhapkar
	Mr. Pranav Thanedar(DCS-COMP)
	Mr. Akshay Shinde
	Mr. Soham Bhoj
	Mr. Nayan Kolekar(DCS-E&TC)
	Mr. Vicky Wakpanjar
	Ms. Rashmi Gawande
Student Ladies Representative	Ms. Kanchan Sonar
	Ms. Pradnya Botre

Students Representative, Cultural Secretary & Representative: In the first student council meeting of the academic year 2017-18 Students Representative, Cultural Secretary & Ladies Representative was elected from the interested students.

Student core-committee: Notices were displayed for seeking student's interest in various activities. Student core-committee from various departments was selected on basis of experience in cultural activities, willingness, management skills, creativity, etc.

Responsibilities of core-committees:

1. Discussion of various events.
2. Finalization of dates and venue.
3. Preparation of Annual Cultural calendar for 2017-18.
4. Discussion of resources and budget for the events.
5. Preparation & sanction of Budget.
6. Selection and Distribution of work to the sub-committees.
7. Selection of D.J.
8. Conveyance of Rules to sub-committees.
9. Approval of the proposed audition dates, venue, budget & resources by the sub-committees.
10. Preparation and display of cultural week schedule.
11. Preparation of itinerary of Jhankaar-2018 event.
12. Submission of bills.
13. Preparation of Report.

Rules for Events

1. Year Down and outside students are not allowed to participate in any of the activities.
2. Weapons, Big vehicles and Animals or any other threatening activities (Explosives material, fire etc.) will not be allowed in the premises.
3. Compulsion of Identity Card for each event.

Responsibilities of Event coordinators

1. Responsibility of issued resources will be with the respective co-ordinators.
2. Display of Notice for respective events with reference number with prior information.
3. Registration form for entry.
4. Take audition according to the registration and the declaration date.
5. Select a judge panel for the audition and the rules for selection.
6. Execution of Audition.
7. Final report with the list of participants.
8. Budget and get sanctioned.
9. Strictly follow the schedule.
10. Submit winner and runner-up of competition if taken.
11. Instruction delivery must not be affected during cultural week.
12. Submit Event report with Photographs with list of document mentioned below
 - i. List of staff in charge and student in charge of respective activity
 - ii. Signed displayed Notice of start and end date of registration and audition date.
 - iii. Rules of selection procedure and student registration forms.
 - iv. Names of judges and their report.
 - v. Audition report.
 - vi. Final report with the list of participants and duration of performance of each participant.
 - vii. Sanctioned budget and expenditure report.
 - viii. Difficulties faced during conduction of activities
 - ix. Suggestion if any to improve activity

Sub-Committees

This year, we formed 34 organising committees to complete all tasks in suitable manner. We deployed students from B.E. & T.E. as co-ordinators & sub co-ordinators in each committee. Students from second year worked as volunteers. Not only it helped us for easy management but also more and more students became part of JHANKAAR & got the opportunity to brush up their management skills. We had separate system running simultaneously for each task without any conflictions. Core committee kept keen watch on the working of each sub-committee.

We had various meets of core committee as well as separate meetings of sub committees as per their requirement. But a part of that, most important part was to conduct general meetings (open to all) of students. We conducted several general meetings this year. Main motive of it was to inform each and every student from college about what is happening under Jhankaar & to clear the doubts as well as take suggestions from them.

This concept of micro-management helped distribute the work load to various committees and work more efficiently.

List of Various Events and Activities

Sr. No.	Event	Staff In-charge	Students In-charge	Core Committee In-charge
1.	Rangoli	Prof. U. D. Dattasamje (H) Prof. V. J. Sonawane	Deepika Bacchhav(E) 8378019380 Smita Kate (M) 7350559402 Snehal Zaware (C) 9604127295	Rashmi Gawande 7038684565 Prof.P.M Ambure
2.	Day's Committee	Prof. P. M. Pardhi (H) Prof. S. V. Mohite Prof. B. R. Pujari	Sayali Gadhak (E) 7841919770 Mugdha Sawale (E) 9158082336 Sanket Huljute (M) 7350878081 Shewta Suryawanshi(M) 7058868038 Sanika Sinalkar (C) 9860276627 Divya Raut (C) 7767015683	Vicky Wakpanjar 8412995489 Prof.P. M Ambure
3.	Girls Safety Committee	Dr. M. P. Dale (H) and All members Internal Complaint committee		Rashmi Gawande 7038684565
4.	Drama Committee	Prof. P. S. Tondewad (H) And committee	Mugdha Sawale (E) 9158082336 Lazina Bagwan(M) 7972707285 Amit Wani (C) 8983553593 Mandar Pimparkar (C) 7972890488	Kanchan Sonar 9011497758 Prof.P.M Ambure

5.	Photography	Prof. R. D. Makhanikar (H) Prof. A. A. Patil Prof. R. N. Yerrawar Prof. N. I. Ujloomwale	Akshay Khurade (E) 9423810621 Sarthak Birari(M) 9545420956 Swaraj Mankar(C) 8275217313	Nayan Kolekar 9860252255 Prof.P.M Ambure
6.	Stage Control	Prof. L. K. Guttedar (H) Prof. N. N. Kumbhar Prof. P. M. Ambure Prof. D. D. Ahir Prof. S.S.Raskar Mr. Yeole Mr. Hawaldar	Shubham Sure (E) 9890624423 Vinay Thorat(M) 9970629347 Vishesh Shah(C) 7350033009	Nayan Kolekar 9860252255 Prof.L.K.Guttedar
7.	Fun Fair	Prof. S. N. Dharwadkar (H) Prof. V. M. Suryavanshi Prof.G. B. Aochar	Sohail Khan (E) 7775062121 Vaibhab Baraskar (E) 7058091900 Himanshu Patil(M) 8554905305 Prashant Kudle(M) 9764333137 Komal Shitole (C) 9146794791 Kejal Rathod (C) 8983221780	Vicky Wakpanjar 8412995489 Prof.L.K.Guttedar
8.	Inauguration/ Felicitation	Prof. V. H. Kamble (H) Prof. M. S. Mali Prof. S. R. Khade Prof. S. A. Hirve	Rutuja Tingre (E) 9604961296 PrathemeshChikarde(M) 7057535457 Rakshanda Chavan(C) 9503484355	Kanchan Sonar 9011497758 Prof.L.K.Guttedar

9.	Drawing & Painting	Prof. J. R. Pansare (H) Prof. P. S. Pandure	Aditya Jagtap (C) 8855019299 Deepanjali Kshirsagar (E) 9823176968 Sharayu Kane(M) 9156001159	Akshay Shinde. 8149158936 Prof.S. A. Salve
10.	Dance Committee	Prof. S. P. Deore (H) Prof. S. D. Wankhede Prof. P. M. Ambure	Tejas Borkar(C) 8007920537 Pratik Bhoyar (C) 7709191672 Manali Bhagat(E) 9158938832 Bhagyshree 9422236755 Ankita Mandale(M) 9881373805 Akshata Waghmare(M) 9767657938	Pradnya Botre. 9527182659 Prof.S. A. Salve
11.	Video Shooting	Prof. B. Y.Pawar (H) Mr. H. G. Mukanak Mr. S. M. Kate Mr. L. J. Parande Mr. P. M. Raikar Mr. R. B. Mulla	Amit Wani(C) 8983553593 Omkar Thorat (E) 8484846181 Pratik Dhore(M) 9923880172	Soham Bhoj 8551010432 Prof.S. A. Salve
12.	Report Generation	Prof. M. M. Siddiqui (H) Prof. P. H. Mohite Prof. H. S. Salave Prof. S. B. Shinde	Aman Pawar(C) 94003928432 Bhagyashree (E) 9422236755	Shekhar Suryawanshi Kanchan Sonar Pradnya Botre Prof.S.R. Kandharkar

13.	Light, Smoke And Sound Committee	Prof. G. B. Deshmukh (H) Prof. K. A. Mahajan Prof. Manish Pathak Mr. S. A. Dhebe	ani Asnain Mulla(C) 9404004097 Vishwanath Manikandan (E) 9763621455 Pavan Sejwol(M) 8379806627	Soham Bhoj. 8551010432 Prof.S.R.Balwan
14.	Stage Decoration	Prof. N. L. Choursiya (H) Prof. P. S. Pandure Prof. Sushant. S. Jadhav	Amit Wani(C) 8983553593 Prachi Gore (E) 8888119102 Mahesh Torane (E) 9284589179 Aman Pawar (C) 94003928432 Abhishek Patil(M) 9405653036	Pranav Thanedar. 9975856638 Prof.S.R.Balwan
15.	Prize Distribution Ceremony	Prof. G. S. Pole (Toppers) Prof.S. R.Balwan(Cultural) Mr. P. P. Bhoge (Sports) Prof. B. D. Nandre (NSS & Other)	C Rakshanda Chavan 9503484355 Pooja Adale (E) 9623386844 Suyesha Joshi(M) 8179442936	Pranav Thanedar. 9975856638 Prof.S.R.Balwan
16.	Mehandi	Prof. S. R. Khonde (H) Prof. S. N. Shaikh	Anagha Shelke (C) Monika Ahire(M) 7057436702 Anuja Gonjari (E) 8855874113	Pradnya Botre. 9527182659 Prof.S.R.Balwan

17.	Singing Committee	Prof. P. A. Keste (H) Prof. V. S. Sawant Prof. Y. M. Ajar	Aditi Kamath(C) 8308282865 Rutuja Tingre (E) 9604961296 Pooja Adale (E) 9623386844 Shradha Hundelkar (C) 9881231464 Abhishek Patil(M) 9405653036 Sphurti Kachare(M) 9970325469	Pradnya Botre. 9527182659 Prof.S.R.Balwan
18.	MESCOE youth inspirer	Prof.C. B.Meshram (H) Prof. P. N. Kota Prof. A. S. Kamble Prof. S. P.Deore	Rakhi Varma(M) 9623755848 Mahesh Torane (E) 9284589179	Priyanka Dhivar. 8378989056 Prof.A.A.Patil
19.	Staff Antakshari	Prof. H. S. Salave (H) Prof. Mahesh Shinde Prof. S.S.Mohitkar	Varad Limaye(M) 8308004168 Pranjali Bhasme(M) 9175851381 Komal Shitole (C) 9146794791 Kejal Rathod (C) 8983221780 Bhargavi Deshpande (E) 8446642734 Deepanjali Kshirsagar (E) 9823176968	Priyanka Dhivar. 8378989056 Prof.A.A.Patil

20.	Art Gallery	All Astitva Departmental Incharge 1.L. K. Guttedar 2. P. B. Biradar (H) 3.S. R. Keshari	Tushar Bade(M) Anagha Shelke (C) Snehal Zaware (C) 9604127295 Prachi Gore (E) 8888119102 Deepanjali Kshirsagar (E) 9823176968	Komal Walke 8552901975 Prof.A. A. Patil
21.	Treasure Hunt	Prof. V. S. Mane (H) Prof. S. H. Pisey Prof. S. S. Kulkarni (FE)	Vinay Thorat(M) 9970629347 Sheetal Salunke(M) 9156829745 Vidya Patil (C) 8888170728 Bhargavi Deshpande (E) 8446642734 Ashish Chopkar (E) 9405870122	Niraj Bhapkar. 9503399123 Prof.A.A.Patil
22.	Finance	Prof. A. A. Patil(H) Prof. Anand Dhavale Prof. M. D. Katole	Sumit Patil(M) 9921935048 Shubham Sure (E) 9890624423 Amit Wani(C) 898355393	Shekhar Suryawanshi 9975128453 Prof.A.A.Patil
23.	Fashion Show	Prof. S. J. Chikhale(H) Prof. A. A. Dhavlikar Prof. P. H. Mohite	Sushant Rokade(M) 9763676661 Pranjali Kshirsath (E) 9028150151 Anuja Gonjar (E) 8855874113	Shekhar Suryawanshi 9975128453 Prof.C.B.Meshram

		Prof. S. R. Khade	Anantmala Wadmare(M) 9673587452 Sagarika Deshpande (C) 9158873212 Rutuja Ghadge (C) 9767681443	
24.	Discipline Committee	Prof. B. D. Nandre (Coordinator) Dr. Vijayalaxmi M. Dr. Ajit Sonawane Dr. S. S. Sarawade Dr. P. P. Mane Dr. S. H. Gawande Dr. A. C. Mitra Dr. S. K. Wagh Prof. R. A. Khan Prof. V. S. Galgali Prof. B. M. Narute Prof. P. P. Bhoge (Coordinator)	Moez Dharwadkar(M) 8983244088 Tushar Bade(M) 7709781993 Mahesh Torane(E) 9284589179	Niraj Bhapkar. 9503399123 Prof.C.B.Meshram
25.	Documentary Competition	Prof. C. B. Meshram (H) Prof. P. R. Rajmane Prof. V. V. Pawale	Dhwanit Mise(M) 9049383453 Amit Wani (C) 898355393 Ashish Chopkar (E) 9405870122	Komal Walke. 8552901975 Prof.C. B. Meshram

26.	Guest Arrangement	Prof. A. R. Patil (H) Prof. V. H. Kamble	Prathemesh Chikorde(M) 8888897509	Shekhar Suryawanshi 9975128453 Prof.C.B.Meshram
27.	Mr& Miss MESCOE	Prof. V.R. Varude (H) Prof. S. P. Gadewar Dr. S. B. Sharma Dr. Ajit Sonawane Astitva Departmental Heads	Vaibhav Bhilare (M) 9561637669 Amit Wani (C) 8983553593 Pooja Adale (E) 9623386844	Priyanka Dhivar. 8378989056 Prof.C.B.Meshram
28.	Student Anchoring Selection Committee	Staff Core Committee	Rakhee Verma(M) 9623755848 Shayan Sadar(C) 8055735468 Pranjali Kshirsath (E) 9028150115	Kanchan Sonar 9011497758 Prof.C.B.Meshram
29.	Practice Arrangement	Prof. P. P. Bhoge (Coordinator) Prof. S. S. Mohitkar (FE) Prof. S. R. Balwan Prof. S. A. Salve Prof. V. V. Thopate Mr. S. B. Sapnar	Varad Limaye(M) 8308004168 Prashant Kudle(M) 9764333137 Aniket Sharma(E) 9158626948 Vaibhav Baraskar(E) 7058091900	Nayan Kolekar 9860252255 Niraj Bhapkar. 9503399123 Akshay Shinde. 8149158936 Prof.C.B.Meshram

30.	Hall Booking, Police Permission & Security	Mr. P. P. Bhoge (H) Prof. S. R. Kandharkar Mr. H. B. Sapnar		Niraj Bhapkar 9503399123 Prof.C.B.Meshram
31.	MESCOE's Got Talent	Prof.S.P.Khedkar(H) Prof.M.A.Malwade Prof.A.A.Patil	Sheetal Salunke(M) 7057588703 Amit Wani (C) 8983553593 Shweta Suryawanshi(M) 9623335658	Pranav Thanedar. 9975856638 Niraj Bhapkar. 9503399123

32.	Student Grievances	Prof. P. N. Kota(H) Prof. S. R. Kandharkar Prof. S. A. Salve	
33.	Website, Publicity and News Paper	Mr. P. V. Raut Mr. Umesh Patil	Prof. S. R. Kandharkar Prof. P. N. Kota
34.	Sports person of the Year	Prof. P. P. Bhoge(H) Prof. G. B. Aochar	Pradnya Botre 9527182659 Prof. C. B. Meshram

 Prof. P. N. Kota
 Prof. S. R. Kandharkar
 Cultural Incharge

 Mr. S. S. Ingole
 Registrar

 Dr. V. N. Kalehole
 Vice-Principal

 Dr. A. A. Keste
 Principal

JHANKAAR 2018 BUDGET

Sr. No.	Event	Staff In-charge	Budget in Rs.
1.	Rangoli	Prof. U. D. Dattasamje (H)	₹ 1,700.00
		Prof. V. J. Sonawane	
2.	Day's Committee	Prof. P. M. Pardhi (H)	₹ 5,000.00
		Prof. S. V. Mohite	
		Prof. B. R. Pujari	
3.	Girls Safety Committee	Dr. M. P. Dale (H)	₹ 0.00
		and All members Internal Complaint committee	
4.	Drama Committee	Prof. P. S. Tondewad (H)	₹ 10,000.00
		And committee	
5.	Photography	Prof. R. D. Makhanikar (H)	₹ 600.00
		Prof. A. A. Patil	
		Prof. R. N. Yerrawar	
		Prof. N. I. Ujloomwale	
6.	Stage Control	Prof. L. K. Guttedar (H)	₹ 2,400.00
		Prof. N. N. Kumbhar	
		Prof. P. M. Ambure	
		Prof. D. D. Ahir	
		Prof. S.S.Raskar	
		Mr. Yeole	
		Mr. Hawaldar	
7.	Fun Fair	Prof. S. N. Dharwadkar	₹ 8,000.00
		(H)	

		Prof. V. M. Suryavanshi	
		Prof.G. B. Aochar	
8.	Inauguration/ Felicitation	Prof. V. H. Kamble (H)	□ 4,000.00
		Prof. M. S. Mali	
		Prof. S. R. Khade	
		Prof. S. A. Hirve	
9.	Drawing & Painting	Prof. J. R. Pansare (H)	□ 800.00
		Prof. P. S. Pandure	
10.	Dance Committee	Prof. S. P. Deore (H)	□ 20,000.00
		Prof. S. D. Wankhede	
		Prof. P. M. Ambure	
11.	Photography & Video Shooting	Mr. P. M. Raikar	□ 7,000.00
		Mr. R. B. Mulla	
12.	Report Generation	Prof. M. M. Siddiqui (H)	□ 4,500.00
		Prof. P. H. Mohite	
		Prof. H. S. Salave	
		Prof. S. B. Shinde	
13.	Light, Smoke And Sound Committee / Stage Decoration	Prof. G. B. Deshmukh (H)	□ 45,000.00
		Prof. K. A. Mahajan	
		Prof. Manish Pathak	
		Mr. S. A. Dhebe	
14.	Stage Decoration	Prof. N. L. Choursiya (H)	□ 40,000.00
		Prof. P. S. Pandure	
		Prof. Sushant. S. Jadhav	
15.	Prize Distribution	Prof. G. S. Pole (Toppers)	□ 41,000.00
	Ceremony	Prof.S. R.Balwan(Cultural)	
		Mr. P. P. Bhoge (Sports)	

		Prof. B. D. Nandre (NSS & Other)	
16.	Mehandi	Prof. S. R. Khonde (H)	□ 1,200.00
		Prof. S. N. Shaikh	
17.	Singing Committee	Prof. P. A. Keste (H)	□ 1,000.00
		Prof. V. S. Sawant	
		Prof. Y. M. Ajgar	
18.	MESCOE youth inspirer	Prof. C. B. Meshram (H)	□ 3,500.00
		Prof. P. N. Kota	
		Prof. A. S. Kamble	
		Prof. S. P. Deore	
19.	Staff Antakshari	Prof. H. S. Salave (H)	□ 5,000.00
		Prof. Mahesh Shinde	
		Prof. S. S. Mohitkar	
20.	Art Gallery	All Astitva Departmental Incharge	□ 20,000.00
		1. L. K. Guttedar	
		2. P. B. Biradar (H)	
		3. S. R. Keshari	
21.	Treasure Hunt	Prof. V. S. Mane (H)	□ 1,500.00
		Prof. S. H. Pisey	
		Prof. S. S. Kulkarni (FE)	
22.	Finance	Prof. A. A. Patil (H)	□ 0.00
		Prof. Anand Dhavale	
		Prof. M. D. Katole	
23.	Fashion Show	Prof. S. J. Chikhale (H)	□ 25,000.00
		Prof. A. A. Dhavlikar	
		Prof. P. H. Mohite	
		Prof. S. R. Khade	

24.	Discipline Committee	Prof. B. D. Nandre (Coordinator)	₹ 700.00
		Dr. Vijayalaxmi M.	
		Dr. Ajit Sonawane	
		Dr. S. S. Sarawade	
		Dr. P. P. Mane	
		Dr. S. H. Gawande	
		Dr. A. C. Mitra	
		Dr. S. K. Wagh	
		Prof. R. A. Khan	
		Prof. V. S. Galgali	
		Prof. B. M. Narute	
		Prof. P. P. Bhoge (Coordinator)	
25.	Documentary Competition	Prof. C. B. Meshram (H)	₹ 2,000.00
		Prof. P. R. Rajmane	
		Prof. V. V. Pawale	
26.	Guest Arrangement	Prof. A. R. Patil (H)	₹ 3,500.00
		Prof. V. H. Kamble	
27.	Mr& Miss MESCOE	Prof. V.R. Varude (H)	₹ 6,000.00
		Prof. S. P. Gadewar	
		Dr. S. B. Sharma	
		Dr. Ajit Sonawane	
		Astitva Departmental Heads	
28.	Student Anchoring Selection Committee	Staff Core Committee	₹ 0.00

29.	Practice Arrangement	Prof. P. P. Bhoge (Coordinator)	₹ 3,000.00
		Prof. S. S. Mohitkar (FE)	
		Prof. S. R. Balwan	
		Prof. S. A. Salve	
		Prof. V. V. Thopate	
		Mr. S. B. Sapnar	
30.	Hall Booking, Police Permission & Security	Mr. P. P. Bhoge (H)	₹ 71,000.00
		Prof. S. R. Kandharkar	
		Mr. H. B. Sapnar	
31.	MESCOE's Got Talent	Prof.S.P.Khedkar(H)	₹ 2,500.00
		Prof.M.A.Malwade	
		Prof.A.A.Patil	
32.	Miscellaneous	Prof. P. N. Kota(H)	₹ 10,000.00
		Prof. S. R. Kandharkar	
33.	Website, Publicity and News Paper	Mr. P. V. Raut	₹ 5,000.00
		Mr. Umesh Patil	
34.	Sports person of the Year	Prof. P. P. Bhoge(H)	₹ 2,500.00
		Prof. G. B. Aochar	
		Total (Rs.)	₹ 353,400.00

Police Permission & Cultural Hall Booking

महाराष्ट्र पोलीस अधिनियम कलम ६८ अन्वये
(जा.क्र./गोप/५३८/२०१७ दि.१६/१२/२०१७)

प्रति,

श्री. नितीन विठ्ठल दिवेकर वय-३० रा.आंबेगाव बु. पुणे मो-८३०८८०६२५७

ज्याज्या आपण अभिनव एज्युकेशन सोसायटी इंग्लिश मेडियम स्कूल आणि ज्युनियर कॉलेज या कॉलेजमध्ये लेखनिक म्हणून नोकरीस आहात. आपले कॉलेजच्या वतीने दिनांक २०/१२/२०१७ रोजी सकाळी ०९.०० ते २१.०० या वेळात श्री गणेश कला क्रिडा रंगमंच येथे वार्षिक स्नेहसंमेलनाचा कार्यक्रम आयोजित केले बाबतचे पत्र इकडील कार्यालयात सादर केले आहे. सदर कार्यक्रमास मा.सहापीर मुक्ता टिळक, सभागृह नेते श्री.श्रीनाथ भिमाले, डॉ.शा.ब.मुजुमदार हे मान्यवर म्हणून उपस्थित राहणार आहेत. त्याअनुषंगाने कार्यक्रमा दरम्यान खालील मुद्द्यांवर लक्ष केंद्रित करून त्याचे उल्लंघन होणार नाही याची खाबरदारी घ्यावी.

१. कार्यक्रमांमुळे दैनंदिन वाहतुकीस अडथळा येणार नाही याची दक्षता घ्यावी.
२. कार्यक्रमांमुळे आजूबाजूचे रहिवासी लोकांना त्रास होणार नाही याची दक्षता घ्यावी.
३. स्पिकरच्या आवाजाची मर्यादा ५००० वॉल्ट्स / स्पिकरची मर्यादा २ ओहम पेक्षा जास्त राहणार नाही याची दक्षता घ्यावी. (शासन निर्णय क्र. ध्वनीप्रवृत्त/२००२/प्रक्र-३ दि. १६/८/२०००) प्रमाणे मर्यादीत ठेवावी.
४. कार्यक्रमाचे वेळी स्त्रिया/मुली यांची छेडछाड तसेच आक्षेपाईत वर्तन होणार नाही याची दक्षता घ्यावी.
५. कार्यक्रमा करीता आपले काडील स्वयंसेवक/सुरक्षा रक्षक नेमावेत.
६. कार्यक्रम दिलेल्या वेळेत संपवावा व पोलीसांनी दिलेल्या सूचनांचे पालन करावे.
७. मा.सुप्रीम कोर्टाने ध्वनीक्षेपका बाबत व आवाजाच्या मर्यादे बाबत जारी केलेल्या आदेशाचे पालन करावे.
८. न्यायालयाने हरकत घेतल्यास अगर सार्वजनिक शांततेच्या कारणावरून पोलीसांनी सामितलेस कार्यक्रम बंद करावा.
९. कार्यक्रमाचे ठिकाणी अगली प्रदायांचा वापर करणेचा ठावळाचा अगर तसे आडवळ्यास कायदेशीर कारवाई करण्यात येईल याची दखल घेण्यात यावी.
१०. कार्यक्रमास महत्वाच्या व्यक्ती येणार असतील तर तसे संबंधित पोलीस ठाण्यात आगाऊ कल्पना द्यावी.
११. कार्यक्रमा साठी स्वतंत्र व पुरेशी पार्किंग व्यवस्था करण्यात यावी.
१२. कार्यक्रमाचे ठिकाणी कार्यक्रमापूर्वी घातपात विरोधी तपासणी करून घ्यावी.
१३. कार्यक्रमाकरीता येणा-या व्यक्तींची व सामान्याची तपासणी करूनच प्रवेश द्यावा. व त्यासाठी स्वयंसेवक नेमावेत.
१४. कार्यक्रमाचे ठिकाणी आग प्रतिबंधक उपाय योजना करावी. विद्युत् पुरवठा सुरक्षित असल्याची खातरजमा करावी.
१५. सदर ठिकाणी कार्यक्रम करण्यास मा.न्यायालयाचे बंधन असल्यास त्या ठिकाणी कार्यक्रमाचे सादरीकरण करण्यात येवू नये.
१६. सादरीकरण करण्याकरीता मा.जिल्हाधिकारी कार्यालय यांचेकडील करमणूक कर विभाग यांची परवानगी घेण्यात यावी.
१७. कार्यक्रमाचे आयोजना दरम्यान कोणाचाही प्रकारे अनुचित प्रकार घडलेस त्याची सर्वस्वी जबाबदारी आयोजकांची राहणार आहे.
१८. सदर कार्यक्रमास सर्व जाती व वर्णांचे लोकांना प्रवेश देण्यात यावा.
१९. कोणाचाही धार्मिक अथवा जातीय भावना नुखावल्या जातील अशा आक्षेपाईत प्रतिमांचे प्रदर्शन, घोषणा देणे, गाणी किंवा वाद्य वाजविणे, हावभाव करणे किंवा तत्सम प्रकार करू नये.

वर नमूद मुद्द्यांचे उल्लंघन होणार नाही या बाबत दक्षता घ्यावी अन्यथा आपल्या विरुद्ध महाराष्ट्र पोलीस अधिनियम कलम १४० प्रमाणे कायदेशीर कारवाई करण्यात येईल याची नोंद घ्यावी.

TRUE COPY

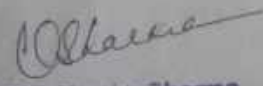
Mrs. Varsha Sharma
Principal
Abhinav Education Society's
English Medium School & Junior College

वरीष्ठ पोलीस निरीक्षक
स्वारगेट पोलीस स्टेशन, पुणे.



श्री गणेश कला क्रीडा मंच
पुणे महानगरपालिका

पुणे महानगरपालिका
श्री गणेश कला क्रीडा मंच

स्वातंत्र्य पुणे ४११ ०४१
ना.क्र. २२४
दिनांक १३/११/२०१७

श्री,
श्री. रंजित
एम. ई. एस. कॉलेज
रंजित नगर पुणे

विषय :- श्री गणेश कला क्रीडा मंच येथील आगवट्ट दिनांक १३/११/२०१७
व वेळ - दुपारी ११:३० - १२:३०
संदर्भ :- दि. १३/११/२०१७ रोजी कार्यालयीन आपला अर्थ.

महोदय,
संबंधित प्रमाणे आगवट्टा करणेची वेळ ही दि. १३/११/२०१७ पासून
दि. १३/११/२०१७ रोजी पुणे - दुपारी ११:३० वा वेळी आपला संस्थेने आधीच केलेल्या
नॉटिस स्नेह संस्थेने - आगवट्टासाठी श्री गणेश कला क्रीडा मंच येथील ठेकागृहाचे आगवट्टा
धाम्य करण्यात आलेले आहे.

श्री गणेश कला क्रीडा मंच येथील अस्तून खालील प्रमाणे सोयी उपलब्ध आहेत.

- १) आगवट्टा करणेची वेळ (११:३०)
- २) आगवट्टा उपकरणे उपलब्ध
- ३) स्वतंत्र पार्किंग उपलब्ध
- ४) मंगला - आगवट्टासाठी उपलब्ध प्रवेशद्वार
- ५) सुरेची विस्तृत व्यवस्था

संबंधितांची खालील प्रमाणे प्रवाहापणे कार्यालयात सादर करणे
आवश्यक आहे.

- १) सुरेची पत्राचार व्यवस्था
- २) आगवट्टा करणेसाठी आगवट्टासाठी इन्डिया फायरिंग पार्ट सेलसाठीचे प्रमाणपत्र.
- ३) सेनादर इत्यादी
- ४) आगवट्टा करणेची व्यवस्था

सुरेची व्यवस्थाबाबतची संपूर्ण जबाबदारी आपल्या संस्थेने घ्यावयाची आहे.

आपला

परिषद लिपिका
श्री गणेश कला क्रीडा मंच
पुणे महानगरपालिका
पुणे महानगरपालिका

Ref No C-19/AS/323
Date 5 10 2017

To,
The **Manager**,
Ganesh Kaia Kreedha Manch,
Pune

Subject - Booking of Hall for Annual Cultural Function 2017-18.

Dear Sir,

MES College of Engineering (Wadia College Campus), Pune 1 is organizing an Annual Cultural Function "JHANKAR 2017-18". We are interested in booking your Central Hall for the upcoming event and request you to please grant concession to our college as this event in Non-Commercial.

Thanking you,

Yours faithfully,



Principal,
MES College of Engineering
Pune 411001

o/c *[Signature]*
[Signature]

Booking Date : 04/01/2018
Full Day

[Signature]
13.5.18
21/10/2017

Schedule of cultural week

JHANKAAR 2018

VASUDHAIVA KUTUMBAKAM- "THE WORLD IS MY FAMILY"

NOTICE OF CULTURAL WEEK

Cultural week is scheduled from 26th December 2017 to 2nd January 2018 as follows:

Date	Activity	Location	Specialty of Day
26 th Dec	Art gallery opening.	Seminar hall (001)	Words make lyrics, lyrics make song, with music of imagination and creativity An art is born.
27 th Dec	Twins day, Selfie and Groupfie day	College parking.	"Kitne aadmi the ?" United we stand, divided we fall.
28 th Dec	Character day.	College parking.	"chal chaiyya chaiyya..." Follow your dreams.
29 th Dec	Fun fair. Food mall. Mismatch day.	College parking	"Carrom ramvannu, juice pivannu ,mazzani life." Health is wealth.
30 th Dec	Signature Day Tabori Day	College parking.	"hat ja re chokre , bheja na thok re..." Stand for your rights.
1 st Jan	Traditional day.	College parking.	"Divided by traditions, united by culture"
2 nd Jan	Red carpet. Prize distribution DJ hungama	College parking.	"Nach na jane, angan tedha" Keep child inside you alive.

(NOTE: Days celebration will start after 2:30pm strictly)

Prof. S. R. Kandharkar
Coordinator & Cultural Head

Prof. P. N. Kota

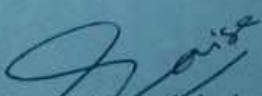
Dr. V. N. Raibhole
Vice Principal

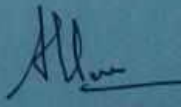
Dr. A. A. Keste
Principal

Jhankaar 2018 Schedule

Sr. No.	Category	Event	Start Time	End Time	Details for Dj and Graphics	Details	Participant /group	Contact No
0	Pre-event	Background Music	12:30	01:00	Play Instrumental Songs with photos of cultural event winners			
1		Curtain Opens	01:00	01:01	Play Music in increasing Volume; display visuals breiefing Jhankaar			
		Yogasan a video	01:00	01:03			Mrunali	860555655
2		Documenary video	01:03	01:13	play video			
3		Podium Anchoring	01:13	01:17		Students , later students call Maam for inviting guests		
4	Inauguration	Calling guest on dias	01:17	01:19	Slow instrumental song			
5	SARASWATI VANDANA	Lighting Diya	01:19	01:21	Saraswati Prayer; Display photo	Maam asks guests to light the lamp		

					Saraswati maa	and pooja		
6	Prize Distributi on	TOPPER S, SPORTS , DOCUM ENTAR Y & photogra phy	01:21	01:41	Prize Distributio n Music; Display Names of winners			
7		Guests take their seats	01:41	01:43		Maam handove r the mic to students		
			01:43	01:44		Lets begin the event with ganesh vandana		
8	DANCE	Ganesh Vandana	01:44	01:47	Play Music for Ganesh Vandana; Display live animation of Ganesh		Sanilka	9860276627
			01:47	01:48		Introduc tion to Rahul		
9	SINGING	RAHUL	01:48	01:51	Display Graphics		RAHUL	8446447008
			1:51	01:52		Introduc tion to TUSHA R and group		

10	DRAMA - 1	TUSHAR R and Group	01:52	01:59			TUSHAR & Group	7058091900
			01:59	02:00		INTRO DUCTI ON TO Ghoom er		
11	DANCE GROUP	GHOOM ER	2:00	02:04	DISPLAY THE NAME OF PARTICIP ANTS		Ghazala	7758022574
			02:04	02:05		Anchors Time		
						INTRO DUCTI ON TO PRANA V		
12	SINGING	PRANA V	02:05	02:09	Play song for PRANAV		Pranav	9975856638
			02:09	02:10		INTOD UCTIO N TO NIKITA & GROUP		
13	DANCE GROUP	NIKITA & GROUP	02:10	02:14	Play song for Nikita & Group		Nikita	8983321950
			02:14	02:15		Introduc e for SAROJ & KOMAL		
14	DANCE DUET	SAROJ & KOMAL	02:15	02:19	Play song for Saroj & Komal		Saroj	8605625468

			2:19	2:22		Call all HOD's on stage for MESCOE TALENT AND LEAD THE YOUTH		
			02:22	02:23		Introduce for MESCOE TALENT		
15	MESCOE TALENT		02:23	02:25	DISPLAY THEIR NAMES			
			02:25	2:26		Introduce for Lead the Youth		
16	LEAD THE YOUTH		2:26	02:34	DISPLAY THEIR NAMES			
			02:34	02:36		Introduce for Sports person of the Year		
17	SPORTS PERSON OF THE YEAR		2:36	02:37	DISPLAY THEIR NAMES			
			02:37	02:38		INTRODUCTION FOR SINGING		

18	SINGING	AKASH DEEP	02:38	2:42	DISPLAY HIS NAME & PLAY KAREOK E IF THERE		Akashdeep	8888705764
			02:42	02:43		ANCHORS TIME		
			02:43	02:44		INTRODUCTION TO DANCE		
19	DANCE GROUP	ICONIC EIGHT	02:44	02:48	Play song		Iconic 8	8446881552
			02:48	02:49				
20	DANCE SOLO	SHIVAM BARBATE	02:49	02:52	Play song for the dance		Shivam	7741969745
			02:52	2:53		INTRODUCTION TO AMAN & Group		
21	DANCE GROUP	AMAN & Group	2:53	02:56	Play Song FOR AMAN		Aman	9403928432
			02:56	02:57		INTRODUCTION TO DANCE		
22	DANCE SOLO	RUCHI SHINDE	2:57	3:00	PLAY Song		Ruchi	8446018873

			03:00	3:01		INTRO DUCTI ON TO DANCE		
23	DANCE GROUP	B.E. MECH	03:01	03:05	PLAY Song		Anantmala	9673587432
			03:05	03:07		INTRO DUCTI ON TO DRAM A		
24	DRAMA - 2	SANDHI	3:07	03:14			Kalyani	7559433544
			3:14	03:15		INTRO DUCTI ON TO DANCE		
25	DANCE GROUP	T.E. MECH	03:15	03:19	PLAY SONG FOR BE MECH		TE MECH	9881373805
			03:19	03:20		ANCHO RS TIME		
			03:20	03:21		INTRO DUCTI ON TO SINGIN G	Piyush	7875569597
26	SINGING	PIYUSH NANDA NE	03:21	03:25	PLAY KARYOK E if there			
			03:25	03:26		INTRO DUCTI ON TO DANCE		
27	DANCE GROUP	B.E. COMP	03:26	03:29	PLAY SONG		Pranav	9975856638

			3;29	3;30		INTRO DUCTI ON TO SINGIN G		
28	SINGING SOLO	AKSHA Y BHOSA LE	03:00	03:34	PLAY KARYOK E if there		Akshay	8485021219
			03:34	03:35		INTRO DUCTI ON TO DANCE		
29	DANCE GROUP	B.E. E&TC	03:35	03:39	PLAY SONG		Harsha	8975546629
			03:39	03:40		INTRO DUCTI ON TO SINGIN G		
30	SINGING DUET	SARTH AK & ABHISH EK	03:40	03:45	PLAY KARYOK E if there		Sarthak	9545420956
			03:45	03:46		INTRO DUCTI ON TO DANCE		
31	DANCE GROUP	SHARD HA, AISHW ARYA AND AKSHA TA	03:46	03:50	PLAY SONG			
			03:50	03:51		INTRO DUCTI ON TO DANCE		
32	DANCE DUET	APEKS HA & SHIVAN I	03:51	03:55	PLAY SONG		Apaksha	8446196521

			03:55	03:56		INTRO DUCTI ON TO DANCE		
33	DANCE SOLO	SIDDHA RTH DHIWA TE	03:56	03:57	PLAY SONG		Siddharth	8668350170
			03:57	03:58		INTRO DUCTI ON TO DANCE		
34	DANCE DUET	PRATIK & TEJAS	03:58	04:01	PLAY SONG		Tejas	8.0008E+10
			04:01	04:02		INTRO DUCTI ON TO SINGIN G		
35	SINGING SOLO	AYUSHI TIWARI	04:02	04:06	PLAY KARYOK E if there		Ayushi	9145297988
			04:06	04:07		INTRO DUCTI ON TO DANCE		
36	DANCE SOLO	ABHIJE ET POTDA R	04:07	04:11	PLAY SONG		Abhijeet	9767249643
			04:11	04:12		Anchori ng for Mr and Ms MESCO E		
37	Awards	Mr and Ms MESCO E award given	04:12	04:17	Play suspense music and display accordingly	Display names of Mr.&Ms . MESCO E, burst		

						crackers, Kota Sir will announce name		
			04:17	04:19		Guests leave the stage & after them Walk of the ramp for winners and runner ups & INTRO DUCTI ON TO RUCHI		
			04:19	04:20		ANCHO RS TIME		
			04:20	04:21		INTRO DUCTI ON TO CULTU RAL SECRE TARY		
38	FASHIO N SHOW	STUDE NTS FASHIO N SHOW	04:21	04:46	PLAY SONG	PLAY SONG		
		CORE COMMI TTEE FASHIO N SHOW				INTRO DUCTI ON TO FASHI ON SHOW		

39	FASHIO N SHOW	CORE COMMI TTEE FASHIO N S	04:46	04:51	PLAY SONG			
					DISPLAY NAMES			
			04:51	04:52		INVITE PRINCI PAL ON STAGE		
40	SPEECH	PRINICP AL SIR	04:52	04:55				
		CULTU RAL SECRET ARY	04:55	04:57	DISPLAY NAMES	Jhankaar CC ,Staff and Students		
41	END Ceremon y	Passayad han	04:57	04:58	DISPLAY DYNANE SHWAR MAHARA J PIC			

Activity Reports

Activity: Rangoli

Staff Coordinators:

Prof. U.D.Dattasmaje (H)

Prof. V.J.Sonowane

Student Coordinators:

Rashmi Gawande

Deepika Bachhav

Snehal Zaware

Plan of Action:

- Plan: Decide theme and allocation of place to Rangoli

a) Requirements: i) 4th floor corridor

ii) Basic Rangoli color

b) Theme : Social Message

c) Total Time : 02 Hours (2:00Pm to 4Pm)

d) Budget:

Sanctioned: 1500/-

Expenditure: 500/-

Number Of Entries: 7

Judges:

- Dr. S.S.Sarwade

i. Prof. S.R.Khonde

ii. Prof. B.M.Narute

Winners:

i) First Prize – Komal Girbide

ii) Second Prize-

Problems Faced:- Light was not sufficient.

Document List :-



Rangoli photos



Rangoli photos

Activity: Mehendi

1.Staff co-ordinators	Mrs.S.R.Khonde Ms. S.N.Shaikh
2.Student co-ordinators	Anagha Shelke(C) Anuja Gonjari (E) Monika Ahire(M)

3.Plan of action

S.No.	Action	Responsible	Deadline
1	Decision of theme for mehendi competition	Staff Coordinators	23/12/17
2	Registration of students	Student Coordinators	23/12/17
3	Arrangement for Competition	Students Coordinators	26/12/17
4	Selection of best design	Staff Coordinators	27/12/17

4.Requirements : Mehendi Cones

5. Budget(Tabular Form) : Sanctioned: 1000 /-
Expenditure : 500 /-

6.Activities carried out : Mehendi design drawing on hand.

7.Rules:

- 1) Discipline to be followed
- 2) I cards are compulsory
- 3) Mehendi design should be drawn without referring any material.
- 4) Time limit 1 hour.
- 5) Final decision on staff and student co coordinator

8.Report of activity:

Mehandi Competition was conducted on 27th December 2017 from 11.30 pm to 12.30 pm.
10 students participated in Competition.

Activity conducted smoothly without any problem.

Winner of Competition : Tabassum Mujawar

Judges of Competition : 1. Prof. Shirin Shaikh 2. Prof. Swati Keshri 3. Prof. Borkar

9.Problems Faced: Nil

10.Suggestions: Nil

11.Photos



Mehandi Design for save planet theme



Mehandi Design of winner

Activity: Drawing & Painting

Activity Name: Drawing & Painting

Staff Coordinators:

- 1) Prof. J. R. Pansare (H)
- 2) Prof. P. S. Pandure

Student Coordinators:

- | | |
|-------------------------|------------------|
| 1) Dipanjali Kshirsagar | 2) Aditya Jagtap |
| 3) Sharayu Kane | 4) Akshay Shinde |

Plan of Action:

- 1) **Plan:** Competition to be conducted for the students.
- 2) **Requirements:** Drawing Sheets
- 3) **Budget:**

Expenditure: 100/-

Competition Report:

- 1) **Competition Date:** 28th December 2017
- 2) **Competition Venue:** Drawing Hall Room No. 117
- 3) **Rules:** No use of mobile or books
- 4) **Selection Criteria:** Composition, color scheme, subject, content, total effects .
- 5) **Judges:**
 1. Prof. C. B. Meshram
 2. Prof. M. Katole
 3. Prof. M. Malwade
- 6) **Number Of Entries:** 9
- 7) **Performance report:**

There were two competitions in the Drawing and Painting.

They were:

Drawing: 5 Participants.

Paintings: 4 Participants.

Total Time for the Drawing & Painting: 2 hrs

Photos:



Staff Incharge

Cultural Incharge

Principal

Activity: Photography

- 1. Staff co-ordinators** Prof. R. D. Maknikar
Prof. A. A. Patil, Prof. R. N. Yerrawar, Prof. N. I. Ujloomwale
- 2. Student co-ordinators** Mr. Akshay Khurde, Mr. Sarthak Birari, Mr. Swaraj Mankar

3. Plan of action

Sr.No.	Action	Responsible	Deadline
1	Registrations	Student Co-ordinators	28/12/2017
2	Selection of Best Picture	Staff Co-ordinators	01/01/2018

4. Requirements None

5. Budget(Tabular Form) Zero

6. Activities carried out Photography Competition for Jhankaar 2018

7. Rules:

- 1). Editing of photos in any way is not allowed.
- 2). Pictures should be taken inside college premises.
- 3). The digital camera should have memory card which is formatted by judges.
- 4). No mixing, matching or morphing is allowed.
- 5). Software such as Photoshop etc. For enhancing image is not permitted.

8. Report of activity:

On 28th Dec 2017, a photography contest was organized for students of M. E. S. College of Engineering, Pune. "1. Perfect Timing (fast shutter), 2. Panning (slow shutter), 3. A Wide Angle, 4).

Creators freedom” was the topic of contest. The contest started at 2.30 PM and the students were given a time of 2 hrs to submit 3 of their best pictures.

9. Problems Faced: None

10. Suggestions: None

11. Photos



1. Photograph submitted by Siddhant Kasbe (Winner)



2. Photograph submitted by Siddhant Kasbe (Winner)



3. Photograph submitted by Bhiungade Swapnil M. (Runner Up)



4. Photograph submitted by Bhiungade Swapnil M. (Runner Up)

Activity: Stage Control

Stage Control

Staff co-ordinators

Prof. L. K. Guttedar (H)
Prof. N. N. Kumbhar
Prof. P. M. Ambure
Prof. S. S. Raskar
Prof. D. D. Ahir

Student co-ordinators

Nayan Kolekar
Soham Bhoj
Pranav Thanedar
Shubham Sure
Akshay Khurade
Yash Joshi

Total Budget: 1850 Rs

Water Bottle :450+Transportation 100

Refresment :1150

Pain relief :150

Rules:

1. Discipline to be followed
2. I cards are compulsory
3. Strictly follow the schedule
4. Execution of Audition

Report of activity:

Jhankaar-18 was conducted on 4th Jan,2018 and smooth fully executed . The distinguish guest of honor Principal Dr. A. A. Keste ,Vice Principal Dr. V. N. Raibhole, Life Member MESCOE Dr.

A .J. Hake ,Registrar Mr. Sanjay Ingole and Prof. Kondhvekar Sir .There were 40 different activity conducted smoothly without any problem.



Stage control team



Jhankaar core team 2018

Graphics Display list FE to ME TOPPERS 2016-2017

Please acknowledge the following list of students for the display of their names on the wall in the same sequence as follows.

Sr. No.	NAME	CLASS	DEPARTMENT
1.	Mr. GUJARATHI SHARVIN SHIRISH	FE	COMPUTER
2.	Mr. ABHIJIT BHOSALE	FE	ENTC
3.	Mr. SANGALE ROHIT BABASAHEB	FE	MECH
4.	Ms. PATIL PRAJAKTA PRAVIN	SE	COMPUTER
5.	Ms. SHAIKH UZMA ZUBAIR	SE	COMPUTER (2NDSHIFT)
6.	Ms. ARDHAPURKAR PURVA SUNIL	SE	ENTC

7.	Mr. SHINDE RUSHIKESH VIJAY Mr. JAIN SHUBHAM ASHOK KUMAR	SE	MECH
8.	Ms. SHAIKH AMINA ABDULLA	TE	COMPUTER
9.	Ms. KOMAL CHANDRAKANT KALE	TE	COMPUTER (2NDSHIFT)
10.	Ms. WAREKAR TEJASWINI MANIKRAO	TE	ENTC
11.	Mr. GOGATE KAUSTUBH ANIL	TE	MECH
12.	Mr. UTEKAR ANKIT ANANT	BE	COMPUTER
13.	Mr. KUNJIR AJINKYA RAJENDRAKUMAR	BE	COMPUTER (2NDSHIFT)
14.	Ms. SAYALI SUDESH MAHAJAN	BE	ENTC
15.	Mr. DESAI AKSHAY	BE	MECH
16.	Ms. VARAL ANURADHA SHIVAJIRAO	ME-I	COMPUTER
17.	Ms. CHAUDHARI SHWETA VYANKAT	ME- II	COMPUTER
18.	Ms. SAWANT DIKSHA ANAND	ME-I	ENTC
19.	Mr. JAGTAP VALLABH VILAS	ME- II	ENTC
20.	Mr. SHELKE GANESH DATTATRAY	ME-I	MECH
21.	Ms. PAWALE ANURADHA ANKUSH	ME- II	MECH

Winners in various events under sports

Sr. No.	EVENT	PRIZE	^
1.	ZEAL RANAANGAN CRICKET TOURNAMENT 2017 (ORGNAIZED BY ZEAL ENGINEERING COLLGE).	RUNNER-UP	CONGRATULATIONS MESCOE CRICKET TEAM !!
2.	SHIVAJI TROPHY 2017 (ORGNAIZED BY AISSMS COE).	RUNNER-UP	CONGRATULATIONS MESCOE CRICKET TEAM !!
3.	ZEAL RANAANGAN CRICKET TOURNAMENT 2018 (ORGNAIZED BY ZEAL ENGINEERING COLLGE).	RUNNER-UP	CONGRATULATIONS MESCOE CRICKET TEAM !!
4.	MILANGE 2K17 (ORGNAIZED BY VIT COE)	WINNER-UP	CONGRATULATIONS MESCOE CRICKET TEAM !!
5.	TEACHING STAFF CRICKET TOURNAMENT	WINNER-UP	CONGRATULATIONS!!
6.	NON-TEACHING STAFF CRICKET TOURNAMENT	RUNNER-UP	CONGRATULATIONS!!
7.	SANJANA JOEEL :- PARTIPATED ALL INDIA CHESS TOURNAMENT 2017 AT BHOPAL (JAGRAN LAKE UNIVERSITY).		CONGRATULATIONS!!
8	BADMINTON (STAFF)- MR.SACHIN KANDARKAR	WINNER UP	CONGRATULATIONS!!
9	MR.SURAJ BALWAN BADMINTON RUNNER UP -	RUNNER-UP	CONGRATULATIONS!!
10	TABLE TENNIS (STAFF) Mr. SACHIN GADEWAR	WINNER UP	CONGRATULATIONS!!
11	Mr. CHETAN MESHARAM	RUNNER-UP	CONGRATULATIONS!!

DOCUMENTARY COMPETITION

Sr. No.>`	NAME OF STUDENTS	DOCUMENTARY NAME
1.	RISHIKESH NAYAK (SE MECH)	TEENAGE PROBLEM

PHOTOGRAPHY COMPETITION

Sr. No.>`	NAME OF STUDENTS
1.	SIDHANT KASBE F.E MECH (WINNER UP)
2.	SWAPNIL BHINUGADE B.E E& TC (RUNNER UP)

MESCOE TALENT

Sr. No.>`	NAME OF STUDENTS	TALENT TYPE
1.	MRUNALI SAWANT (BE COMP)	YOGA

LEAD THE YOUTH WINNER

Sr. No.	NAME OF STUDENT	TOPIC
1.	RUSHIKESH NAIK	SE MECH

JHANKAAR 2018

CULTURAL CORE COMMITTEE

❖ STUDENTS

Sr. No.	POST	NAME
1.	DEPARTMENTAL CULTURAL SECRETARY OF COMPUTER	Mr. PRANAV THANEDAR
2.	MEMBER	Mr. AKSHAY SHINDE
3.	MEMBER	Mr. SOHAM BHOJ

4.	DEPARTMENTAL CULTURAL SECRETARY OF ELECTRONICS & TELECOMMUNICATION	Mr. NAYAN KOLEKAR
5.	MEMBER	Mr. VICKY WAKPANJAR
6.	MEMBER	Ms. RASHMI GAWANDE
7.	DEPARTMENTAL CULTURAL SECRETARY OF MECHANICAL	Ms. KOMAL WALKE
8.	MEMBER	Ms. PRIYANKA DHIVAR
9.	MEMBER	Mr. NIRAJ BHAPKAR
10.	LADIES REPRESENTATIVE	Ms. KANCHAN SONAR
11.	LADIES REPRESENTATIVE	Ms. PRADNYA BOTRE
12.	STUDENTS REPRESENTATIVE	Mr. NAYAN KOLEKAR
13.	CULTURAL SECRETARY	Mr. SHEKHAR SURYAVANSHI

❖ **STAFF**

Sr. No.	NAME	DEPARTMENT
1.	Dr. A. A. Keste	Chairman
2.	Dr. V. N. Raibhole	Member
3.	Mr. S. S. Ingole	Member
4.	Mr. S. R. Balwan	Member
5.	Ms. S. A. Salve	Member
6.	Mr. L. K. Guttedar	Member
7.	Mr. P. M. Ambure	Member
8.	Mr. C. B. Meshram	Member
9.	Mr. A. A. Patil	Member
10.	Mr. P. P. Bhoge	Member
11.	Mr. S. R. Kandharkar	Member Secretary
12.	Mr. P. N. Kota	

Sr. No.	Category	Event	Start Time	End Time	Details for Dj and Graphics	Details	Participant/group	Contact No
0	Pre-event	Background Music	12:30	01:00	Play Instrumental Songs with photos of cultural event winners			
1		Curtain Opens	01:00	01:01	Play Music in increasing Volume; display visuals briefing Jhankaar			
		Yogasana video	01:00	01:03			Mrunali	860555655
2		Documentary video	01:03	01:13	play video			
3		Podium Anchoring	01:13	01:17		Students, later students call Maam for inviting guests		
4	Inauguration	Calling guest on dias	01:17	01:19	Slow instrumental song			

5	SARASWATI VANDANA	Lighting Diya	01:19	01:21	Saraswati Prayer; Display photo Saraswati maa	Maam asks guests to light the lamp and pooja		
6	Prize Distribution	TOPPERS, SPORTS, DOCUMENTARY & photography	01:21	01:41	Prize Distribution Music; Display Names of winners			
7		Guests take their seats	01:41	01:43		Maam handover the mic to students		
			01:43	01:44		Lets begin the event with ganesh vandana		
8	DANCE	Ganesh Vandana	01:44	01:47	Play Music for Ganesh Vandana; Display live animation of Ganesha		Sanilka	9860276627
			01:47	01:48		Introduction to Rahul		
9	SINGING	RAHUL	01:48	01:51	Display Graphics		RAHUL	8446447008

			1:51	01:52		Introduction to TUSHAR and group		
10	DRAMA - 1	TUSHAR and Group	01:52	01:59			TUSHAR & Group	7058091900
			01:59	02:00		INTRODUCTION TO Ghoomer		
11	DANCE GROUP	GHOOMER	2:00	02:04	DISPLAY THE NAME OF PARTICIPANTS		Ghazala	7758022574
			02:04	02:05		Anchors Time		
						INTRODUCTION TO PRANAV		
12	SINGING	PRANAV	02:05	02:09	Play song for PRANAV		Pranav	9975856638
			02:09	02:10		INTRODUCTION TO NIKITA & GROUP		
13	DANCE GROUP	NIKITA & GROUP	02:10	02:14	Play song for Nikita & Group		Nikita	8983321950

			02:14	02:15		Introduce for SAROJ & KOMAL		
14	DANCE DUET	SAROJ & KOMAL	02:15	02:19	Play song for Saroj & Komal		Saroj	8605625468
			2:19	2:22		Call all HOD's on stage for MESCOE TALENT AND LEAD THE YOUTH		
			02:22	02:23		Introduce for MESCOE TALENT		
15	MESCOE TALENT		02:23	02:25	DISPLAY THEIR NAMES			
			02:25	2:26		Introduce for Lead the Youth		
16	LEAD THE YOUTH		2:26	02:34	DISPLAY THEIR NAMES			
			02:34	02:36		Introduce for Sports person of the Year		

17	SPORTSPERSON OF THE YEAR		2:36	02:37	DISPLAY THEIR NAMES			
			02:37	02:38		INTRODUCTION FOR SINGING		
18	SINGING	AKASHDEEP	02:38	2:42	DISPLAY HIS NAME & PLAY KAREOKE IF THERE		Akashdeep	8888705764
			02:42	02:43		ANCHORS TIME		
			02:43	02:44		INTRODUCTION TO DANCE		
19	DANCE GROUP	ICONIC EIGHT	02:44	02:48	Play song		Iconic 8	8446881552
			02:48	02:49				
20	DANCE SOLO	SHIVAM BARBATE	02:49	02:52	Play song for the dance		Shivam	7741969745
			02:52	2:53		INTRODUCTION TO AMAN & Group		

21	DANCE GROUP	AMAN & Group	2:53	02:56	Play Song FOR AMAN		Aman	9403928432
			02:56	02:57		INTRODUCTION TO DANCE		
22	DANCE SOLO	RUCHI SHINDE	2:57	3:00	PLAY Song		Ruchi	8446018873
			03:00	3:01		INTRODUCTION TO DANCE		
23	DANCE GROUP	B.E. MECH	03:01	03:05	PLAY Song		Anantmala	9673587432
			03:05	03:07		INTRODUCTION TO DRAMA		
24	DRAMA - 2	SANDHI	3:07	03:14			Kalyani	7559433544
			3:14	03:15		INTRODUCTION TO DANCE		
25	DANCE GROUP	T.E. MECH	03:15	03:19	PLAY SONG FOR BE MECH		TE MECH	9881373805
			03:19	03:20		ANCHOR S TIME		

			03:20	03:21		INTRODUCTION TO SINGING	Piyush	7875569597
26	SINGING	PIYUSH NANDANE	03:21	03:25	PLAY KARYOKE if there			
			03:25	03:26		INTRODUCTION TO DANCE		
27	DANCE GROUP	B.E. COMP	03:26	03:29	PLAY SONG		Pranav	9975856638
			3:29	3:30		INTRODUCTION TO SINGING		
28	SINGING SOLO	AKSHAY BHOSALE	03:00	03:34	PLAY KARYOKE if there		Akshay	8485021219
			03:34	03:35		INTRODUCTION TO DANCE		
29	DANCE GROUP	B.E. E&TC	03:35	03:39	PLAY SONG		Harsha	8975546629
			03:39	03:40		INTRODUCTION TO SINGING		
30	SINGING DUET	SARTHAK & ABHISHEK	03:40	03:45	PLAY KARYOKE if there		Sarthak	9545420956

			03:45	03:46		INTRODU CTION TO DANCE		
31	DANCE GROUP	SHARDHA , AISHWAR YA AND AKSHATA	03:46	03:50	PLAY SONG			
			03:50	03:51		INTRODU CTION TO DANCE		
32	DANCE DUET	APEKSHA & SHIVANI	03:51	03:55	PLAY SONG		Apaksha	8446196521
			03:55	03:56		INTRODU CTION TO DANCE		
33	DANCE SOLO	SIDDHART H DHIWATE	03:56	03:57	PLAY SONG		Siddharth	8668350170
			03:57	03:58		INTRODU CTION TO DANCE		
34	DANCE DUET	PRATIK & TEJAS	03:58	04:01	PLAY SONG		Tejas	8.0008E+10
			04:01	04:02		INTRODU CTION TO SINGING		

35	SINGING SOLO	AYUSHI TIWARI	04:02	04:06	PLAY KARYOKE if there		Ayushi	9145297988
			04:06	04:07		INTRODUCTION TO DANCE		
36	DANCE SOLO	ABHIJEET POTDAR	04:07	04:11	PLAY SONG		Abhijeet	9767249643
			04:11	04:12		Anchoring for Mr and Ms MESCOE		
37	Awards	Mr and Ms MESCOE award given	04:12	04:17	Play suspense music and display accordingly	Display names of Mr.&Ms. MESCOE, burst crackers, Kota Sir will announce name		
			04:17	04:19		Guests leave the stage & after them Walk of the ramp for winners and runner ups & INTRODUCTION		

						TO RUCHI		
			04:19	04:20		ANCHOR S TIME		
			04:20	04:21		INTRODU CTION TO CULTURA L SECRETA RY		
38	FASHION SHOW	STUDENT S FASHION SHOW	04:21	04:46	PLAY SONG	PLAY SONG		
		CORE COMMITT EE FASHION SHOW				INTRODU CTION TO FASHION SHOW		
39	FASHION SHOW	CORE COMMITT EE FASHION S	04:46	04:51	PLAY SONG			
					DISPLAY NAMES			
			04:51	04:52		INVITE PRINCIPA		

						L ON STAGE		
40	SPEECH	PRINICPA L SIR	04:52	04:55				
		CULTURA L SECRETAR Y	04:55	04:57	DISPLAY NAMES	Jhankaar CC ,Staff and Students		
41	END Ceremony	Passayad han	04:57	04:58	DISPLAY DYNANESH WAR MAHARAJ PIC			

Activity : Staff Antakshari

Staff Coordinators:

1) Prof. H. S. Salave (H)

1) Prof. Mahesh Shinde

2) Prof. S.S.Mohitkar

Student Coordinators:

1) Priyanka Dhivar.

2) Varad Limaye

3) Pranjali Bhasme

4) Komal Shitole

5) Kejal Rathod

6) Bhargavi Deshpande

7) Deepanjali Kshirsagar

Plan of Action:

a) **Plan:** Meetings to be conducted for taking rounds with students.

Four rounds of antakshari: i) Plain antakshari ii) Bollywood quiz iii) Dumb Charades iv) Rapid fire

a) **Requirements:** 514 Seminar Hall

b) **Budget:**

Sanctioned: Rs. 2000/-

Expenditure: Rs. 2500/-

On stage performance report: As discussed in meeting with students, it was decided to invite all teaching and non-teaching staff for Antakshari. Invitations were sent through email to all staff. On the event day, all staff are personally invited to participate and represent their department. There were four rounds for the Staff Antakshari.

Round 1: Plain Antakshari **Time:** 25 mins

Round 2: Bollywood Quiz (Audio, Image, Complete the Dialogue) **Time:** 25 mins

Round 3: Dumb Charades **Time:** 20 mins

Round 4: Rapid Fire **Time:** 20 mins

Total Time for the Staff Antakshari: 90 minutes

Photos:



Staffs Participating in Antakshari



The winner of the event: E& TC and FE Department

Activity: Mr& Miss MESCOE

- **Staff co-ordinators :** Prof. V.R. Varude (H), Prof. S. P. Gadewar, Dr.S. B. Sharma, Dr. Ajit Sonawane
- **Core Committee Member:** Priyaka Dhivar(BE MECH)
- **Student co-ordinators :** Vaibhav Bhilare (BE MECH), Amit Wani (TE COMP), Pooja Adale (BE E&TC).
- **Plan of action:**

Sr. No.	Action	Responsible	Deadline
1	Review last year's report of Mr. & Miss MESCOE event	All Student coordinators	20 th Sept 2017
2	Meeting of all student coordinators to decide format of this year's event.	All Student coordinators	15 th Dec 2017
3	Finalizing the format of this year's event with staff coordinator.	Student and Staff coordinators	18 th Dec 2017
4	Prepare attractive notice for the event and put on notice board.	Prof. V.R. Varude	18 th Dec 2017
5	Compile questions for aptitude and GK test	All student coordinators	19 th Dec 2017
6	Review aptitude and GK test questions	All staff coordinators	20 th Dec 2017
7	Conduct Aptitude and GK Test	All Student coordinators	21 st Dec 2017
8	Evaluation of answers	All Student coordinators	21 st Dec 2017
9	Prepare list of exercises for physical test and scoring criteria.	Prof. Prasad P Bhoge	25 th Dec 2017
10	Conduct Physical test of 6 shortlisted students.	Prof. Prasad P Bhoge	28 th Dec 2017
11	Third Round – Self introduction and Extempore Round	All Staff and student coordinators	28 th Dec 2017

12	Preparation of assessment criteria and scoring sheets for Personal Interview.	All student co-ordinators	27 th Dec 2017
13	Final Round of Personal Interview.	Judges chosen from senior faculty members. (Choice of judges by Prof. V. R. Varude in consultation with Cultural In-Charge – Prof. P. N. Kota)	29 th Dec 2017
14	Decide Mr. And Miss MESCOE and seal the result to be opened at the time of Jhankaar 2017.	Judges of final round	29 th Dec 2017
15	Announcement of Mr. And Miss MESCOE at Jhankaar 2017.	Priyanka Dhivar	4 th Jan 2018

- **Requirements**

- Room No. 117 for Round 1 and Round 3.
- Refreshments for judges during final round.
- Refreshments for the judge during physical round.
- Sundry expenses like photocopying, printouts etc.

- **Budget**

Sanctioned	Actual Expenses	
Rs. 6000/-	Trophies	1500/-
	Sash	400/-
	Refreshments	150/-
	Stationary and Crackers	404/-

- **Auditions Report:**

1) Date

21/12/2017 : Aptitude Test + G.K.

28/12/2017 : Physical Test

28/12/2017 : Self Introduction and Extempore Round

29/12/2017 : Personal Interview

04/01/2018 : Announcement of Mr. And Miss MESCOE in Jhankaar 2016-2017

2) Venue

Room No. 117 (Aptitude Test + G.K., Self introduction and Extempore Round)

Round Table Conference Room 201 (Personal Interview)

- **Rules**

- There will be 4 rounds of selection – Aptitude test + GK, Physical, Self Introduction and Extempore, and Personal Interview
- Aptitude test + GK : This round has 20 marks. It consists of 10 Aptitude questions and 10 GK MCQ questions.
- Physical : This round will test the physical abilities and fitness of the participants.
- Self Introduction and Extempore : The candidate has to come on stage and give self-introduction in 3 minutes for 5 marks. In extempore round the candidate will be given a topic on the spot and 2 minutes to think on it and a further 5 minutes to present his topic which include the question and answers session also.
- Personal Interview : A personal interview is conducted by the Respective HOD's of all the departments and the Principal and Vice Principal and Prof. P. N. Kota

- **Judges**

Round 3:

Prof. S. P. Gadewar, Dr. S.B.Sharma, Dr. Ajit Sonawane

Round 4:

Prof. V.N.Chougule , Dr. Ajit Sonawane, Prof P. B. Chopde, Prof Sheikh

- **Number of Entries** : 6 (2 from each department)
- **Summary** :

Rounds	Dates	Marks
Round 1	21 December, 2017	20

(Aptitude Test + GK)		
Round 2 (Physical Fitness)	28 December, 2017	20
Round 3 (Self Introduction and Extempore)	28 December, 2017	20
Round 4 (Personal Interview)	29 December, 2017	20

- **Photographs of Round 2(Physical test):**





Physical test photos

- **Final Results:**

Total score of participants were as follows:

- (1) Sanika Sinalkar-
- (2) Akshay Shinde -
- (3) Pooja Jahagirdar-
- (4) Nayan Kolekar-
- (5) Palak Barai-
- (6) Moez Dharwadkar-

Mr. Mescoe of 2017 – Moez Dhawadkar(B.E. Mech)

Ms. Mescoe of 2017 – Sanika Sinalkar (B.E. Comp)

Activity: Treasure Hunt

1. **Staff co-ordinators :** Prof. V.S. Mane (H), Prof. S. H. Pisey, Prof S. S. Kulkarni

2. **Core Committee Member:** Niraj Bhapkar (TE MECH)

Student co-ordinators : Mrs. Sheetal Salunke, Mr. Jaydeep Chaukekar, Mr. Vinay Thorat,
Mrs. Vidya Patil

3. **Plan of action:**

Sr. No.	Action	Responsible	Deadline
1	Review last year's report of Treasure Hunt event	All Student coordinators	21 th Dec 2017
2	Meeting of all student coordinators to decide format of this year's event.	All Student coordinators	22 nd Dec 2017
3	Finalizing the format of this year's event with staff coordinator.	Student and Staff coordinators	26 th Dec 2017
4	Prepare attractive notice for the event and put on notice board.	Prof. V.S.Mane	26 th Dec 2017
6	Preparing The question Sets	All Student coordinators	27 st Dec 2017
7	Final Confirmation	All Staff coordinators	29 rd Dec 2017
8	Conducting Actual Round	All Student coordinators	30 rd Dec 2017
9	Declaring The Winners	Niraj Bhapkar & Staff co-ordinators	2 nd Jan 2018

4. **Requirements**

- All Labs Of All Three Branches.
- Seminar Hall -001
- MESCOE Parking.
- Expenses like photocopying, Printouts, Posters etc.

5. **Budget**

Sanctioned	Actual Expenses
Rs. 1500/- (One thousand Five Hundred)	Stationary & Miscellaneous - 668/-(Six Hundred Sixty Eight)

6. Rules

- There will be group of 2 students
- Three rounds will be taken, they are in continuous loop.
- Decision of coordinators will be final.
- Any harm to college property will not be entertained.

7. **Number of Entries** : 30 groups (60 students)

8. **Photographs** :



Treasure Hunt round Photos



Treasure Hunt prize distribution photo

9. Final Results:

Winner - Prashant Kudale & Manoj Nawale (TE MECH)

Runnerup – Sayali Gadakh & Shalmalee Ghag (B.E. E& TC)

Activity: Art Gallery

1. Staff co-ordinators

Prof. P. B. Biradar (H)

Prof. L. K. Guttedar

Prof..S. R. Keshari

Student co-ordinators

Komal Walke(M)

Tushar Bade(M)

Anagha Shelke (C)

Snehal Zaware (C)

Prachi Gore (E)

Deepanjali Kshirsagar (E)

Sanction Budget :20000 Rs/-

Total Budget: 12669Rs/-

Rules:

1. Submit entries before deadline.
2. Submitted articles should not be copied from others.
3. Art work should not be religious.
4. Strictly follow the schedule

Report of activity:

Art Gallery includes the following activities:

- a) Articles
- b) Poems
- c) Painting

- d) Sketching
- e) Photography
- f) Sculpture
- g) Drawing
- h) Sketches

1) Deadlines for the submission of the articles of the above mentioned subject was decided up to 24th Dec 17. Student coordinators prepared the list of materials required to purchase for the Art gallery.

2) Entries received-

(a) Articles and Poems: 03+03

(b) Photography: 02

(c) Sculpture:01

(d) Paintings& Sketching:08

Inauguration of art gallery was held on 26th Dec'17 and art gallery continued up to 2nd Jan 18

Students were judged by the respective teachers who were present for the inauguration of art

Gallery on the basis of Idea used, Moral of the art work, Creativity and perspective of the students.

Problems Faced:

1. Art work submitted by student was not on time.
2. Decoration limits, due to no place to hang or drill on the wall.
3. Difficult to have lights effect due to outdoor location.

Suggestions:

1. Art work submission process should start very early as soon as possible.
2. College should motivate the art work of student during the event.

3. Guest from the art world should be invited(can be local artist).
4. College should provide platform for live performance.

Winners and runner up names of ART GALLERY.

1) Article

- 1) Akshay Chorage B.E Comp (Winner)
- 2) Somesh Pathak T.E Comp (RUNNER Up)

2) Poem

- 1) Komal Walke B.E Mech (Winner)
- 2) Chinmay Sheth S.E Mech (RUNNER Up)

3) Painting

- 1) Aditi Shah B.E E& Tc (Winner)
- 2) Siddhes Choudhary S.E Comp (RUNNER Up)

4) Skretching

- 1) Rohit Angre B.E Mech (Winner)
- 2) Rajesh Khamkare B.E E& Tc (RUNNER Up)

5) Photography

- 1) Swapnil Bhinugade B.E E& Tc (Winner)
- 2) Snehal Bhandari T.E E& Tc (RUNNER Up)

6) Sculpture

- 1) Yogesh Rakh B.E E& Tc (Winner)



Theme of art gallery



Students are observing art gallery activities



Art gallery Team 2018



Cordinators Judging the articles

Activity: Light, Smoke and Sound Committee

- **Staff co-ordinators** Prof. G.B.Deshmukh
Prof. K. A. Mahajan, Prof. Manish Pathak
- 2. **Student co-ordinators** ani Asnain Mulla(C), Vishwanath Manikandan (E) Pavan Sejawol(M)

3. Plan of action:

Sr.No.	Action	Responsible	Date
1	Three Quotations were taken	Staff Co-ordinators	27/12/2017
2	One of these was finalized (DREAM Events)	Staff Co-ordinators	28/12/2016

4. Requirements Sound system(main event), Monitors, Mike with stand, Cordless mike, Collar Mike, Podium Mike, Live Mixer, Led par cans, Face Light, Sharpy, Smoke, Follow spot, walkie, Earphone Mike, Fun Fair, Amplifier, Laser Light, Controller

5. Budget 85000/

6. Expenditure 84960/

8. Report of activity: On 2nd Jan 2018, a DJ was organized for students of M. E. S. College of Engineering, Pune sound system with DJ provided. The Event started at 2.30 PM and the students were given a time of 1 hr 30 minutes .On 4 Jan 2018 sound sytem provided to student at Ganesh kala Krida Mandir for Jhnkaar2018 for full day.

9. Problems Faced: None

10. Suggestions: None

11. Photos



Lights and Sound



Lights and Sound

Activity: Inauguration /Falicitation

Staff Coordinators:

1. **Prof. V. H. kamble (H)**
2. Prof. M. S. Mali
3. Prof. S. R. Khade
4. Prof. S. A. Hirve

Student Coordinators

1. Ms. Rutuja Tingre(E)
2. Ms. Prathmesh Chikarde(M)
3. Ms. Rakshanda Chavan(C)

Plan of Action:

1. Plan:: To take all required things for Inauguration/ Felicitation one hour before at Ganesh Kala Krida Mandir on 4th Jan 2017.

Requirement:

1. Saraswati idol
2. Samai, Pooja Plate
3. Flowers , bouquet, showl, coconut
4. Water Bottle, table cloths , Flower pots
5. Flower plants with pot

Budget:

Budget Estimated: 4000/- **Expenditure:** – 4628/-

Inauguration/ Felicitation of Jhankar 2017 was graced by Former Principal Mr. M. N. Khondhavekar, Principal Dr. A. A. Keste, vice Principal Dr. V. N. Raibhole and Registrar Mr. S. S. Ingole. Function conducted smoothly .

Problem Faced: Nil

Suggestions: Nil



Welcome of chief guest by students



“Saraswati Pujan” by chief guest & dignitaries



Felicitation of chief guest Dr. M. N. Kondhvekar by principal Dr. A. A. Keste

Activity: Drama Committee

1. **Staff co-ordinators :** Ms. P. S. Tondewad (H), Prof. V. H. Kamble, Prof. S. R. Balwan, Prof. S. A. Salve, Prof. S. R. Kandharkar, Prof. Seema Chikhle.
2. **Core Committee Member:** Kanchan Sonar (BE E&TC)
3. **Student co-ordinators :** Mugdha Sawale (BE E & TC), Lazina Bagwan(BE Mech), Amit Wani (BE COMP), Mandar Pimparkar (BE COMP).

4. Plan of action:

Sr. No.	Action	Responsible	Deadline
1	Prepare notice for the drama auditions and put on notice board.	Ms. P. S. Tondewad	18 th Dec 2017
2	Arranging the auditions.	All Student coordinators.	20 th Dec 2017
3	Final round of auditions.	All Student coordinators.	23 rd Dec 2017
4	Declaring the results .	Judged by all committee members.	25 th Dec 2017

5. Requirements

- Seminar hall 001 Round 1 and Final Round.

6. Budget

Sanctioned	Actual Expenses
Rs. 10,000/-	Not required.

7. Auditions Report:

1) Date

22/12/2017 : First round of drama.

23/12/2017 : Results announced .

2) Venue

Seminar hall 001.

Rules

- Total time on stage , not to exceed 7 min including self - introduction and the announcing of the titles and authors of the selections.
- Auditions will be judged on Theme selection, Coordination, Script writing and dialogue delivery.
- Drama should have some message for society.
- No entries will be entertained without registration.

8. Judges

Round 1:

Prof. S. R. Kandharkar

Prof. V. H. Kamble

Prof. S. A. Salve

Prof. S. R. Balwan

Ms. P. S. Tondewad

9. Number of Entries : 4

10. Selected Group :

Group 1 : Tushar & Group.(Kachra – Social Awareness)

Group 2 : Amit Wani & Group(Boys' Responsibility).

11. Photographs of performance at Jhankaar 2k18

“Kachra” Social awareness drama by Tushar and group -



“Kachra” Social awareness drama by Tushar and group



“Kachra” Social awareness drama by Tushar and group

Activity: Fashion Show

Staff Coordinators:	1. Prof. S. J. Chikhale (H) 2. Prof. A. A. Dhavlikar 3. Prof. S. Khade 4. Prof. P. H. Mohite
Student Coordinators:	Shekhar Suryawanshi (M) Sushant rokade (M) Pradnya Botre (C)

Plan of Action:

- a) **Plan:** Auditions to be conducted for the students.

Requirements: 4th floor corridor

Budget:

Sanctioned: 25000/-

Expenditure: 7082/- (Drapery)

Auditions Report:

- a) **Audition Dates:** 18th to 23rd December 2017

Audition Venue: 4th floor corridor

Rules: Walking straight and giving different poses.

Selection Criteria: Attitude, Confidence, Body Language, Grace, Stage Presence.

Judges:	1. Prof. S. J. Chikhale (H) 2. Prof. A. A. Dhavlikar 3. Prof. S. Khade 4. Prof. P. H. Mohite
----------------	---

Number of Entries: 83

Selected: 52

On stage performance report:

There were two themes in the fashion show. They were:

Theme 1: Retro

Time: 5 mins

Theme 2: Indian Royal Wedding

Time: 5 mins

Theme 2: Formal

Time: 08 mins

Total Time for the Fashion Show: 20 mins

Photos:



Fashion show Photos

Activity: Singing Committee

STAFF COORDINATORS:

- Prof. P. A. Keste (H)
- Prof. V. S. Sawant
- Prof. Y. M. Ajgar

STUDENT COORDINATORS:

- Aditi Kamath(C)
- Rutuja Tingre (E)
- Pooja Adale (E)
- Shraddha Hundelkar (C)
- Abhishek Patil(M)
- Sphurti Kachare(M)

PLAN OF ACTION:

- **Plan:** There were two auditions for selecting participants for the main event. The participants were judged on the basis of their stage presence, vocal range and vocal quality by a panel of judges from all the respective departments.
- **Number of participants:**
Audition 1 - 26
Audition 2 - 22
- **Number of selected Participants for Jhankaar: 7**
- **Requirements:** Nil

- **Budget:**

Sanctioned – 1000 Rs.

Received – 0 Rs.

- **Expenditure:** Nil

AUDITION REPORT:

a) **Audition Dates :**

Audition 1 – 21/12/1017

Audition 2 – 28/12/2017

b) **Audition Venue :**

Audition 1 – Seminar hall(001)

Audition 2 – Seminar hall(514)

c) **Selection Criteria:**

Participants were judged on the basis of their stage presence, vocal range and vocal quality by a panel of judges from all the respective departments.

d) **Judges :**

Audition 1:

Prof. V.S. Sawant

Prof. M.U. Pathak

Prof. M.V. Vaishampayan

Prof. S.A. Borkar

Audition 2:

Prof. S.R. Khade

Prof. Y.M. Ajgar

Prof. C.B. Meshram

e) **Number of entries:**

Round 1: 26

Round 2: 22

f) **Performance Report:**

The Auditions were conducted and 7 out of 48 participants were shortlisted. These 7 participants performed on the main Jhankaar day(4th Jan 2018).

Photos:



Ayushi Tiwari(SE COMP)



Sarthak Birari(TE MECH)



Pranav Thanedar(BE COMP)



Akashdip Singh(BE MECH)



Rahul Sayalekar(BE COMP)

Activity: Dance Committee

Staff Coordinators:

- Prof. S.P. Deore(HEAD COORDINATOR)
- Prof. S.D.Wankhede
- Prof. P.M.Ambure

Student Coordinators:

- Pradnya Botre(HEAD COORDINATOR)
- Tejas Borkar
- Pratik Bhoyar
- Manali Bhagat
- Bhagyshree
- Ankita Mandale
- Akshata Waghmare

Plan of Action:

- **Plan:** Auditions to be conducted for the students.
- **Requirements:** Seminar hall 001
- **Budget:**

Sanctioned: 20000/-

Expenditure: 8214/-

Auditions Report:

1st Audition Date: 22nd December 2017

Audition Venue: Seminar hall 001.

Selection Criteria: Expressions,Coordination,Steps.

Judges:

- Prof. S.P.Deore
- Prof. S.D. Wankhede.
- Prof.P.M. Ambure

Number Of Entries:

- SOLO:- 12
- GROUP:-9
- Duet: 3

Selected:

- SOLO:-4
- GROUP:-9
- Duet:4

2nd Audition Date: 27th December 2016

Audition Venue: Seminar hall 001.

Selection Criteria: Expressions,Coordination,Steps.

Judges:

- Prof. S.P. Deore
- Prof. S.D. Wankhede
- Prof. P .M. Ambure
- Tejas Borkar(Dance coordinator)

Number Of Entries:

- SOLO:- 12
- GROUP AND DUET:- 12

Selected:

- SOLO:-4
- GROUP:-9
- DUET:-4

FINAL LIST:-

SOLO	
1.	Siddhart Diwate
2.	Abhijit Poddar
3.	Ruchi Shinde
4.	Shivam Barbate

GROUP	
1.	Aman Pawar and Group
2.	TE Mech
3.	Anantmala and Group
4.	Nikita Khandagale and Group
5.	Ghazala Mirani and Group
6.	BE Entc
7.	Iconic 8
8.	BE Comp
9.	BE Mech

DUET	
1.	Tejas and Pratik
2.	Shivani and Apeksha
3.	Aishwarya and Shraddha and Akshata
4.	Komal and Saroj

On stage performance report:

Total Time for the DANCE: 60 minutes

Photos:



Dance Photos



Dance Photos

Activity: Anchoring Committee

Staff Coordinators:

- Prof. S.R. Kandharkar
- Prof.C.B.Meshram
- Prof.A.A.Patil
- Prof.P.M Ambure
- Prof.L.K.Guttedar
- Prof.S.R.Balwan
- Prof.S.A.Salve

Student Coordinators:

- Rakhee Verma
- Shayan Sadar
- Pranjali Kshirsath
- Kanchan Sonar
- Bhagyashri puranik
- Shubham Sure

Plan of Action:

- **Plan:** Auditions to be conducted for the students interested in anchoring.
- **Requirements:** 4th floor Seminar Hall 421
- **Budget:** NIL

Auditions Report:

1. Audition Dates:

- Round 1:** 20st December 2017
- Round 2:** 21nd December 2017

2. Audition Venue: 4th floor Seminar Hall 421

3. **Selection Criteria:** Confidence, clarity, audibility.

4. **Judges:**

- Prof. M. M. Dhanvijay (H)
- Prof. S.R. Kandharkar
- Prof. Meshram
- Prof. Anup Patil
- Prof. S.R. Balwan
- Prof. S.A. Salve

5. **Number Of Entries:** 20

6. **Selected anchors:** 12

- Juveria Shaikh
- Gargee Jadhav
- Sumit Tambe
- Abhishek Bagul
- Rajneesh Chaudhari
- Rushikesh Naik
- Ashwini Pawar
- Kalyani Patil
- Rohit Dhanorkar
- Nazneen Inamdar
- Rakhee Varma
- Pranjali Shirsath
- Pranoti Kholam

Photos:



On Stage Performance of Anchors



On Stage Performance of Anchors

Activity: Stage Decoration

Staff Coordinators	Prof. N. L. Choursiya (H) Prof. P.S.Pandure Prof. Sushant. S. Jadhav
Student Coordinators	Pranav Thanedar(C) Amit Wani(C) Prachi Gore (E) Mahesh Torane (E) Aman Pawar (C) Abhishek Patil(M)

*Plan of Action

Plan	<ul style="list-style-type: none"> • Meeting was held regarding planning of stage decoration. • To search for vendor for decorations as per the dimensions. • To keep track of activities.
Requirements	LED screen (10 12) Decoration set Petals for stage Slide Wings
Budget	Rs.85000/
Activities carried out	Decoration order was given to Perfect Productions for Rs.84960 /- All student co-coordinators helped in completing the Stage decoration for Jhankaar 2018 on time with respect to all circumstances.

Rules

- Material should be ecofriendly.
- Wastage should be minimum.
- Light and unbreakable material should be used properly.
- Material should be reusable.
- Transportation should be easy.

Report of the Activity

- LED screen used in the activity was highly appreciated.

- On the day of the events, staff co-coordinator reported in time and completed the work on time.
- Students learned how to manage the things according to the situations and time remaining.
- Active Participation of the students.

Problems Faced

Nil

Suggestions

Nil

Activity Photographs



Photo1: Prize Distribution Jhankaar 2018



Photo 2: Prize Distribution Kho-Kho Jhankaar 2018

Activity: Fun Fair

1. Staff coordinators	Mr. S.N Dharwadkar Mr V.M Suryawanshi Mr. G. B. Aochar
2. Student coordinators	Mr. Sohail Khan Mr. Vaibhab Baraskar Mr. Himanshu Patil Mr. Prashant Kudle Ms. Komal Shitole Ms. Kejal Rathod

3. Plan of action

S.No.	Action	Responsible	Deadline
1	Selection of area for Fun –Fair activity	All Staff Coordinator	23/12/2017
2	Registration of stalls	Student Coordinators	27/12/2017
3	Arrangement for Stalls	Students Coordinators	29/12/2017
4	Selection of best stall	Staff Coordinators	29/12/2017
4. Requirements		Tables from labs and seminar hall ,Decorative materials	
5. Budget (Tabular Form)		Sanctioned: 2500/- Expenditure : 2335/-	

6. Activities carried out	1. Arrangement of stalls 2. Selection of best stall for food and games
----------------------------------	---

7. Rules:

- | |
|---|
| <ul style="list-style-type: none"> • Discipline to be followed. • I-cards are compulsory. • Final decision on staff and student coordinator. |
|---|

8.Report of activity:

Fun fair 2017-18 was conducted on 29nd Dec 2017 from 2 pm to 6 pm. Fun –Fair was inaugurated by honorable Principal Dr. A. A. Keste and 11 stalls participated in Fun-Fair. Among those best two stalls were selected as follows

- Veg Samosa stall (Shruti More)
- Veg Manchurian (Shruti Ratul)

Activity conducted smoothly without any problem.

9.Problems Faced:

- No such Problems encountered on the day of event

10.Suggestions:

The event was a grand success with no outside intruders and interferences. Comments and feedbacks received were positive and overwhelming.

11.Document list: Notices, Photos:



Inauguration Ceremony of Funfair-2018



Food Stall



Food Stall



Game Stall

Activity: Prize Distribution Ceremony

Staff co-ordinators : Prof. G.S. Pole
: Prof. S. A. Salve

Student co-ordinators : Rakshanda Chavan

Plan of action:

1)Plan .

Email to all HOD regarding Toppers list year 2016-2017
Hard copy of Result Analysis from all HoD
Result verification
Preparation of toppers list & its approval.
Verbal communication with B.E.Toppers
Invitation letters preparation & dispatch of letters
Sanction of Prize Amount for Prize.
Order for printing on Gold Medal.
Verbal Communication with to FE, SE,TE,BE and ME students & Acknowledgement
Certificate of Merit Preparation & sequence of certificate
Certificate & Gold Medal arrangement
Anchoring of activity by Student.

2) Requirements

- Hard copy of Result Analysis 2016-17
- Letter Head for BE and ME Student Invitation
- Certificate of Merit(23 Qty),
- Certificate of Gold Medal (1Qty)
- Gold Medal (1 Qty)

3) Budget

- Sanctioned : Total **Rs.23000/-**
- Expenditure: Total **Rs.23000/-**

Item	Amount
Cash Prize	22000/-
Gold Medal	1000/-
Total	23000/-

Following students are awarded with "Certificate of Merit and Prize" in academics and for standing first in AY 2016 -17.

Sr. No.	NAME	CLASS	DEPARTMENT	AMOUNT IN RS.
1.	Mr. GUJARATHI SHARVIN SHIRISH	FE	COMPUTER	500
2.	Mr. TONDARE ROHIT SHIRISH	FE	ENTC	500
3.	Mr. SANGALE ROHIT BABASAHEB	FE	MECH	500
4.	Ms. PATIL PRAJAKTA PRAVIN	SE	COMPUTER	500
5.	Ms. SHAIKH UZMA ZUBAIR	SE	COMPUTER (2NDSHIFT)	500
6.	Ms. ARDHAPURKAR PURVA SUNIL	SE	ENTC	500
7.	Mr. SHINDE RUSHIKESH VIJAY	SE	MECH	500
	Mr. JAIN SHUBHAM ASHOK KUMAR			500
8.	Ms. SHAIKH AMINA ABDULLA	TE	COMPUTER	500
9.	Ms. KOMAL CHANDRAKANT KALE	TE	COMPUTER (2NDSHIFT)	500
10.	Ms. WAREKAR TEJASWINI MANIKRAO	TE	ENTC	500
11.	Mr. GOGATE KAUSTUBH ANIL	TE	MECH	500
12.	Mr. UTEKAR ANKIT ANANT	BE	COMPUTER	500
13.	Mr. KUNJIR AJINKYA RAJENDRAKUMAR	BE	COMPUTER (2NDSHIFT)	500
14.	Ms. SAYALI SUDESH MAHAJAN	BE	ENTC	500
15.	Mr. DESAI AKSHAY KAKASO	BE	MECH	500
16.	Ms. SAYALI SUDESH MAHAJAN	BE	ENTC	5000 (Vishwanath and Nalini Kulkarni award for Overall Topper)
17.	Mr. DESAI AKSHAY KAKASO	BE	MECH	6000 (Khushroo Mistry Award for BE Mech Topper)
18.	Ms. VARAL ANURADHA SHIVAJIRAO	ME-I	COMPUTER	500
19.	Ms. CHAUDHARI SHWETA VYANKAT	ME- II	COMPUTER	500

20.	Ms. SAWANT DIKSHA ANAND	ME-I	ENTC	500
21.	Mr. JAGTAP VALLABH VILAS	ME- II	ENTC	500
22.	Mr. SHELKE GANESH DATTATRAY	ME-I	MECH	500
23.	Ms. PAWALE ANURADHA ANKUSH	ME- II	MECH	500

Problems Faced: Nil

Suggestions: Nil

Document list:

- Invitation letters to B.E. and ME -II Toppers.
- Marklist of all Dept. FE to B.E. and ME Toppers (one for each dept.)
- Result Analysis of F.E. to B.E all Branches.
- 23 Certificate of Merit + 1 Prin. Kondhwekar Gold Medal Certificate

Prize Distribution Ceremony Snaps:



Principal Dr. A. A. Keste awarding cash Prize and Certificates to Class Toppers



Vice -Principal Dr. V. N. Raibhole awarding cash Prize and Certificates to Class Toppers



Prof. Dr. A. J. Hake awarding cash Prize and Certificates to Class Toppers



Registrar Mr. Sanjay Ingle awarding cash Prize and Certificates to Class Toppers



Prof. M.N. Kondhawekar awarding cash Prize and Certificates to Class Toppers

Activity: Day's Committee

1. Staff co-ordinators Prof. Pravin Pardhi (H)
 Prof. S. V. Mohite
 Prof. B. Pujari

2. Student co-ordinators Ms. Sayali Gadak
 Ms. Mugdha Sawale
 Mr. Sanket Huljute
 Ms. Shweta Suryawanshi
 Ms. Sanika Sinlkar
 Ms. Divya Raut

3. Plan of action

S.No.	Action (Day)	Slogans	Deadline
1	Twins Day, Selfie Day and Groupfie Day	“Kitne aadmi the ?” United we stand, divide we fall.	27 th Dec, 2017
2	Character Day	“Chal chaiyya chaiyya...” Follow your dreams.	28 th Dec, 2017
3	Mismatch Day	“Carrom ramvannu, juice pivannu, mazzani life.” Health is Wealth.	29 th Dec, 2017
4	Signature Day Tapor Day	“hat ja re chokre, bheja na thok re...” Stand for your rights.	30 th Dec, 2017

5	Traditional Day	“Divided by Tradition, united by culture”	1 st Jan, 2018
6	Red Carpet Day	“Nach na jane, angan tedha” Keep child inside you alive.	2 nd Jan, 2018

4.Requirements Decorative materials (For Inauguration)

5.Budget Sanctioned: Rs.5000/-
Expenditure : Rs.2959/-

6.Rules:

- Discipline to be followed
- I cards are compulsory
- Final decision will be taken by staff and student co ordinator

7.Report of activity:

The days celebrated in Jhankaar 17-18 reflected the mix emotion of old and modern lifestyle. Character Day, Twins Day, Tapani Day celebrated as the old day fashion in a glimpse; whereas Red Carpet Day, Selfie Day and Groupfie Day represented the modern lifestyle. On tradition day students opted traditional attire. That proved the saying for our beloved nation “Vasudhaiv Kutumbkam”(The World is my family).

8.Photos



Character Day



Best Costume



Best Couple



Twins Day



Best Boys Pair



Best Girls Pair



Best Photo

Activity: MESCOE Youth Inspirer

Staff Coordinators:

1. Prof. Chetan B Meshram(H)
2. Prof. P. N. Kota
3. Prof. A. S. Kamble
4. Prof. S. P. Deore

Student Coordinators:

1. Rakhi Varma
2. Mahesh Torane

Plan of Action:

1. The auditions were conducted on the 21th of September 2017, Monday.
2. Entries-14
3. Round 1- 8 selected, 6 rejected
4. Final round, 1 selected and 7 rejected.

Requirement:

1. Sound system

Budget: NA

Budget Estimated: NA

Budget Received: NA

Expenditure: NA

Audition Report:

Audition Date: 21st & 25th September 2017

1. **Audition Venue:** Seminar Hall 509
2. **Rehearsal Venue:** Seminar Hall 514
3. **Rules:**
 - a. Round 1- Presentation using Power Point / Latex. & 10 min.
 - b. Round 2 – Presentation using Power Point / Latex. & 10 min.

c. Rehearsals –Final performance

4. Selection Criteria:

- a. Round 1 - Performance time of 10 mins was given to participants to showcase their talent on presentation, body language, communication skill and topic .
- b. Round 2 – Shortlisted candidates were further assessed.
- c. Rehearsals- Final track performance was assessed.

5. Judges/Volunteers:

1. Prof. Chetan B. Meshram (H)
2. Prof. Shital . Salve
3. Prof. Amol Kamble
4. Prof. Mita Shimpi

6. Number of Entries: 14

7. Selected:

1. Rushikesh Naik

8. Photos:



Participant presenting their ideas



Participant presenting their ideas



Experts evaluating participant's performance

Activity Name: Publicity and Web Management

Staff Coordinators:

1. Mr. P. V. Raut
2. Mr. Umesh Patil

Plan of Action:

Jhankaar website has uploaded for registration and schedule before one month of JHANKAAR event.

Requirement:

Budget: 5000/-

Expenditure: 4131/-

Problem Faced: Nil

Suggestions: Nil

Activity: Cultural Events Prize Distribution

1. Staff co-ordinators	Prof.S.R.Balwan.
2. Student co-ordinators	1) Pranav Thanedar. 2) Rakshanda Chavan. 3) Pooja Adale. 4) Suyesha Joshi.

3. Plan of action

S.No.	Action	Responsible	Deadline
1	Number of event	Staff Coordinators	23/12/17
2	Winner list	Student Coordinators	29/12/17
3	Arrangement for Price distribution	Students Coordinators	04/01/18

4. Requirements Trophies

5. Budget(Tabular Form) Sanctioned: 16000/-
Expenditure :16000/-

6. Activities carried out

7. Report of activity:

Prize distribution was conducted on 04th January 2018 from 3.30 pm to 4.30 pm. and during Jhankkar 2018. Activity conducted smoothly without any problem.

8. Problems Faced:

1) Nil

9.Suggestions:

Nil

10.Photos



Staff antakshari prize distribution



Cultural Event prize distribution



Cultural Event prize distribution

Activity: Video Shooting

Staff Coordinators	Prof.Bhushan Y Pawar Mr.Sunil M. Kate Mr.Harshal Muknak Mr.Laxman Parande Mr.P. M. Raikar Mr.Rais Ali Mr.Nilesh Raut
---------------------------	---

Plan of Action:

1)Plan	-All staff coordinator meeting has been arranged on 19 th Dec 2017 -And plan the record all videos and photos for all events during Jhankaar 2017 Role And Responsibility with Timeframes : <ol style="list-style-type: none"> 1) Mr.Kate,Muknak will handle video shooting in Jhankaar 18 for 2 hrs from 12.30pm to 2.30pm 2) Mr.Ali,Raut will handle video shooting in Jhankaar 18 for next 2 hrs from 2.30pm to 4.30pm 3) Mr.Parande, Raikar will handle video shooting in Jhankaar 17 for next 2 hrs from 4.30 to 6.30pm and onwards. 4) Mr. Nilesh will see the photography during the days and Jhankaar 18 -Smooth Conduction of Video Shooting and Phtotography will be done by Prof.Pawar.
2)Requirements	Nil
3)Activities carried out	<ol style="list-style-type: none"> 1) Meetings carried out on 19th Dec 2017 and 26th Dec 2017. 2) Electrical Arrangement has been carried out at Ganesh Kala Krida Manch. 3) Mr.Kate,Muknak handled video shooting in Jhankaar 18 for 2 hrs from 12.30pm to 2.30pm 4) Mr.Ali,Raut handled video shooting in Jhankaar 18 for next 2 hrs from 2.30pm to 4.30pm 5) Mr.Parande, Raikar will handle video shooting in Jhankaar 18 for next 2 hrs from 4.30 to 6.30pm and onwards. 6) And Mr. Nilesh will see the photography during the days and Jhankaar 18 7) Prepared the DVDs of shooting videos and videos are uploaded on server

Report of activity:

- 1) Video has been covered on art gallery , funfair , Treasure hunt, Jhankaar Gathering
- 2) Photos captured of all activities.

Snap taken at Art Gallery



Prize Distribution Ceremony



DJ Hungama



3) Prepared the DVDs of shooting videos

Problems Faced:

- 1) Electric connection at Ganesh Kala Krida Munch.
- 2) Advanced Feature Computer Machine is not there for storing and editing the videos and pictures taken

Suggestions:

- 1) College should purchase the 15 meters HDMI cable and audio extension cable.
- 2) One Advanced Feature Computer Machine should be there for storing the videos and photos

Activity: Discipline Committee

1. Staff co-ordinators

Sr. No.	Name of Staff	
1	Prof. B. D. Nandre	Coordinator
2	Dr. Vijayalaxmi M.	Member
3	Dr. Ajit Sonawane	Member
4	Dr. S. S. Sarawade	Member
5	Dr. P. P. Mane	Member
6	Dr. S. H. Gawande	Member
7	Dr. A. C. Mitra	Member
8	Dr. S. K. Wagh	Member
9	Prof. R. A. Khan	Member
10	Prof. V. S. Galgali	Member
11	Prof. B. M. Narute	Member
12	Prof. P. P. Bhoge	Coordinator

2. Student Coordinator- NIL

3. Plan of action

S.No.	Action
1	Maintain discipline during Fun –Fair activity on 29-12-2017
2	Maintain discipline during Main cultural event JHANKAR on 4-1-2018

4. Requirement- 4 Bouncer during Main cultural event JHANKAR on 4-1-2018

5. Activities carried out

1. Fun –Fair activity on 29-12-2017
2. Main cultural event JHANKAR on 4-1-2018

6. Rules:

- | |
|---|
| <ol style="list-style-type: none"> 1) Discipline to be followed 2) I cards are compulsory |
|---|

3) Final decision on staff coordinator

7. Problems Faced:

- 1) Permission for DJ at parking of MESCOE
- 2) Outside students try to enter forcefully during DJ.

8. Suggestions:

As DJ System is there, it creates lot of noise pollution in environment. Students only concentrate on dance. If DJ system is stopped then student can think over innovative ideas for implementing stalls.

9. Document list: Notices

Activity: Documentary and Short Film Competition

Staff Coordinators:

1. Prof. Chetan B Meshram(H)
2. Prof. P. R. Rajmane
3. Prof. V. V. Pawale

Student Coordinators:

1. Dhwanit Mise
2. Amit Wani
3. Komal Walke.

Plan of Action:

1. The auditions were conducted on the 22th of December, Monday.
2. Entries-4
3. Round 1- 2 selected, 2 rejected
4. final round, 2 selected and 2 rejected.

Requirement:

1. Sound system and Projector.

Budget: NA

Budget Estimated: NA

Budget Received: NA

Expenditure: NA

Audition Report:

Audition Date: 27th December 2017

Audition Venue: Seminar Hall 509

Rehearsal Venue: Seminar Hall 514

Rules:

- d. Round 1- Video Presentation & 10 min.
- e. Round 2 – Video Presentation & 10 min.
- f. Rehearsals –Final performance

Selection Criteria:

- a. Round 1 - Performance time of 10 mins was given to participants to showcase their talent on topic, Content, presentation and message.
- b. Round 2 – Shortlisted candidates were further assessed.
- c. Rehearsals- Final track performance was assessed.

Judges/Volunteers:

5. Prof. Chetan B. Meshram (H)
6. Prof. Anup Patil
7. Prof. Seema Chikhale
8. Prof. Sagar Shinde

Number of Entries: 4

Selected:

2. Paper Boy Team

Photos:



Participant presenting their documentary



Participant presenting their documentary



Experts evaluating participant's performance

Activity: MESCOE Talent

Staff Coordinators:

- 1) Prof. S.P. Khedkar (H)
- 2) Prof. A. A. Patil
- 3) Prof. M. A. Malwade

Student Coordinators:

- 1) Neeraj Bhapkar
- 2) Sheetal Salunke
- 3) Aditi Kamath
- 4) Shweta Suryawanshi

Plan of Action:

- a) **Plan:** Auditions to be conducted for the students In Two rounds.
- b) **Requirements:** Seminar Hall 001.
- c) **Budget:**
Sanctioned: 2500/-
Expenditure:

Auditions Report:

- a) **Audition Dates:** First Round 23rd December 2017 & Second Round 28th December 2017.
- b) **Audition Venue:** Seminar Hall 001.
- c) **Rules:** solo performance upto 5 min.
- d) **Selection Criteria:** Uniqueness, Confidence, Stage presence, Overall impression & Talent
- e) **Judges:**
 - i. Prof. S. R. Kandharkar
 - ii. Prof. Rashmi Gawande
 - iii. Prof. A. A. Patil
 - iv. Prof. M. A. Malwade
 - v. Prof. Pradnya Bohre
- f) **Number Of Entries: 17**

Winner : Karan Shah (Computer)

Runner-up: Akshay Jain (Mechanical)

Photos:



Auditions for MESCOE talent



Participants showing their talents



Participants showing their talents



Runner-up (Akshay Jain)

Activity: Expenditure Report

Sr. No.	Event	Staff In-charge	Budget in Rs.	Actual Expense
1.	Rangoli	Prof. U. D. Dattasamje (H)	₹ 1,700.00	₹ 500.00
		Prof. V. J. Sonawane		
2.	Day's Committee	Prof. P. M. Pardhi (H)	₹ 5,000.00	₹ 2,959.00
		Prof. S. V. Mohite		
		Prof. B. R. Pujari		
3.	Girls Safety Committee	Dr. M. P. Dale (H)	₹ 0.00	₹ 0.00
		and All members Internal Complaint committee		
4.	Drama Committee	Prof. P. S. Tondewad (H)	₹ 10,000.00	₹ 0.00
		And committee		
5.	Photography	Prof. R. D. Makhanikar (H)	₹ 600.00	₹ 0.00
		Prof. A. A. Patil		
		Prof. R. N. Yerrawar		
		Prof. N. I. Ujloomwale		
6.	Stage Control	Prof. L. K. Guttedar (H)	₹ 2,400.00	₹ 1,850.00
		Prof. N. N. Kumbhar		
		Prof. P. M. Ambure		
		Prof. D. D. Ahir		
		Prof. S.S.Raskar		
		Mr. Yeole		
Mr. Hawaldar				
7.	Fun Fair	Prof. S. N. Dharwadkar	₹ 8,000.00	₹ 2,335.00

		(H)		
		Prof. V. M. Suryavanshi		
		Prof.G. B. Aochar		
8.	Inauguration/ Felicitation	Prof. V. H. Kamble (H)	₹ 4,000.00	₹ 4,628.00
		Prof. M. S. Mali		
		Prof. S. R. Khade		
		Prof. S. A. Hirve		
9.	Drawing & Painting	Prof. J. R. Pansare (H)	₹ 800.00	₹ 0.00
		Prof. P. S. Pandure		
10.	Dance Committee	Prof. S. P. Deore (H)	₹ 20,000.00	₹ 4,207.00
		Prof. S. D. Wankhede		
		Prof. P. M. Ambure		
11.	Photography & Video Shooting	Mr. P. M. Raikar	₹ 7,000.00	₹ 6,000.00
		Mr. R. B. Mulla		
12.	Report Generation	Prof. M. M. Siddiqui (H)	₹ 4,500.00	₹ 0.00
		Prof. P. H. Mohite		
		Prof. H. S. Salave		
		Prof. S. B. Shinde		
13.	Light, Smoke And Sound Committee / Stage Decoration	Prof. G. B. Deshmukh (H)	₹ 45,000.00	₹ 84,960.00
		Prof. K. A. Mahajan		
		Prof. Manish Pathak		
		Mr. S. A. Dhebe		
14.	Stage Decoration	Prof. N. L. Choursiya (H)	₹ 40,000.00	
		Prof. P. S. Pandure		
		Prof. Sushant. S. Jadhav		
15.	Prize Distribution	Prof. G. S. Pole (Toppers)	₹ 41,000.00	₹ 39,404.00

	Ceremony	Prof.S. R.Balwan(Cultural)		
		Mr. P. P. Bhoge (Sports)		
		Prof. B. D. Nandre (NSS & Other)		
16.	Mehandi	Prof. S. R. Khonde (H) Prof. S. N. Shaikh	□ 1,200.00	□ 540.00
17.	Singing Committee	Prof. P. A. Keste (H) Prof. V. S. Sawant Prof. Y. M. Ajgar	□ 1,000.00	□ 0.00
18.	MESCOE youth inspirer	Prof.C. B.Meshram (H) Prof. P. N. Kota Prof. A. S. Kamble Prof. S. P.Deore	□ 3,500.00	□ 0.00
19.	Staff Antakshari	Prof. H. S. Salave (H) Prof. Mahesh Shinde Prof. S.S.Mohitkar	□ 5,000.00	□ 2,500.00
20.	Art Gallery	All Astitva Departmental Incharge 1.L. K. Guttedar 2. P. B. Biradar (H) 3.S. R. Keshari	□ 20,000.00	□ 12,669.00
21.	Treasure Hunt	Prof. V. S. Mane (H) Prof. S. H. Pisey Prof. S. S. Kulkarni (FE)	□ 1,500.00	□ 669.00
22.	Finance	Prof. A. A. Patil(H) Prof. Anand Dhavale Prof. M. D. Katole	□ 0.00	□ 0.00

23.	Fashion Show	Prof. S. J. Chikhale(H)	₹ 25,000.00	₹ 3,541.00
		Prof. A. A. Dhavlikar		
		Prof. P. H. Mohite		
		Prof. S. R. Khade		
24.	Discipline Committee	Prof. B. D. Nandre (Coordinator)	₹ 700.00	₹ 0.00
		Dr. Vijayalaxmi M.		
		Dr. Ajit Sonawane		
		Dr. S. S. Sarawade		
		Dr. P. P. Mane		
		Dr. S. H. Gawande		
		Dr. A. C. Mitra		
		Dr. S. K. Wagh		
		Prof. R. A. Khan		
		Prof. V. S. Galgali		
		Prof. B. M. Narute		
		Prof. P. P. Bhoge (Coordinator)		
25.	Documentary Competition	Prof. C. B. Meshram (H)	₹ 2,000.00	₹ 0.00
		Prof. P. R. Rajmane		
		Prof. V. V. Pawale		
26.	Guest Arrangement	Prof. A. R. Patil (H)	₹ 3,500.00	₹ 0.00
		Prof. V. H. Kamble		
27.	Mr& Miss MESCOE	Prof. V.R. Varude (H)	₹ 6,000.00	₹ 804.00
		Prof. S. P. Gadewar		
		Dr. S. B. Sharma		
		Dr. Ajit Sonawane		
		Astitva Departmental Heads		

28.	Student Anchoring Selection Committee	Staff Core Committee	₹ 0.00	₹ 0.00
29.	Practice Arrangement	Prof. P. P. Bhoge (Coordinator)	₹ 3,000.00	₹ 0.00
		Prof. S. S. Mohitkar (FE)		
		Prof. S. R. Balwan		
		Prof. S. A. Salve		
		Prof. V. V. Thopate		
		Mr. S. B. Sapnar		
30.	Hall Booking, Police Permission & Security	Mr. P. P. Bhoge (H)	₹ 71,000.00	₹ 55,500.00
		Prof. S. R. Kandharkar		
		Mr. H. B. Sapnar		
31.	MESCOE's Got Talent	Prof.S.P.Khedkar(H)	₹ 2,500.00	₹ 0.00
		Prof.M.A.Malwade		
		Prof.A.A.Patil		
32.	Miscellaneous	Prof. P. N. Kota(H)	₹ 10,000.00	₹ 3,961.00
		Prof. S. R. Kandharkar		
33.	Website, Publicity and News Paper	Mr. P. V. Raut	₹ 5,000.00	₹ 4,131.00
		Mr. Umesh Patil		
34.	Sports person of the Year	Prof. P. P. Bhoge(H)	₹ 2,500.00	₹ 0.00
		Prof. G. B. Aochar		
		Total (Rs.)	₹ 353,400.00	₹ 231,158.00

Report Generation Committee Views

Staff co-ordinators :	Prof. P. H. Mohite Prof. H. S. Salave Prof. S. B. Shinde
Student co-ordinators	Mr. Aman Pawar Ms. Bhagyashree

Plan of action

1)Plan	1. Follow up of reports from all committee in charges. 2. Collection of soft copy in required format
2)Requirements	Paper Rim 2 Colour print outs
3)Budget	Stationary from office and colour print out from Comp. Dept.
4)Activities carried out	Rough report is forwarded to all committee in charges to verify their respective report.

Report of activity:

As it is required to collect the reports in proper format from all committees, it takes lot of time to complete Jhankaar report 2018. After collection all reports, all reports are combined in one copy. For further correction rough report is forwarded to all committee in charges to verify their respective report and then final copy is created.

Problems Faced: Collection of all reports in proper format in given deadlines.

Report and suggestions from student Core Committee

The teams for Jhankaar 2018 were formed in first week of September. The planning of the programme also started simultaneously. The staff and students were all set to start with the preparations. Everyone including the staff members, students and non-teaching staff took all the efforts for the success of this program.

All the events took place on decided day and time. Everything was well co-ordinated. No programme is possible without small problems and Jhankaar 2k18 was no exception. There were slight problems during the execution of the tasks which actually happened rarely but was really well handled and managed by the respective co-ordinators. The staff members were very supportive and understanding. They helped the co-ordinators in planning and execution of programme.

Even during curfew in Pune staff and the core committee members were present in college because the final show was to happen the next day itself. The dedication if the management members is worth a word of appreciation. The enthusiastic participation of students for dance, art gallery, singing and all other competitions was overwhelming.

The final programme took place in a very organised way, just the way it was planned. Every person present on stage, at back stage and everyone in the management team is responsible for the success of this programme.

The extra benefit we team members got from this programme was the enhancement of our management skills and leadership qualities, we met new people and it was an amazing experience to be a part of such a great team. Everyone has equally worked hard for the successful execution of Jhankaar.

-Shekar Suryawanshi
Cultural Secretary (2016-17)

The event was very successful. But the participation of the students were not upto the mark. The period of Jhankaar was not right as during that period 2nd year and 1st year exams were going on. It should be in the month of Feb. So it will attract more no of students. Not necessary to celebrate all days , only few days should be celebrated like Traditional day,DJ, Fun Fair etc. Quite happy for the support from teaching staff

- Nayan Kolekar (E&TC)

The event was quite successful. All the provisions were excellent and staff was also very supportive. But the staff should have been more supportive as during “Days Celebration” their contribution was very less. Also from next time it will be nice if the days celebrated were less.

- Kanchan Sonar (E&TC)

The main event was successful. All the staff leading upto the event was not supportive. Some staff members did not try to understand and students point of view and misunderstandings were created which were taken up to unnecessary heights. Only those days should be celebrated where the students involvement is more. Staffs enthusiastic involvement would be highly appreciated.

-Pradnya Botre(Comp)



CAT of MESCOE

Report Generation Committee

Prof. P. H. Mohite Prof. S. B. Shinde Prof. H. S. Salve

**Mr. Shekhar Suryawanshi
Cultural Secretary**

**Kanchan Sonar & Pradnya Botre
Ladies Representative**

**Prof. S. R. Kandharkar
Jhankaar 2018 Head**

**Prof P. N. Kota
Cultural Head**

**Mr. S. S. Ingole
Registrar**

**Dr. V. N. Raibhole
Vice-Principal**

**Dr. A. A. Keste
Principal**

Modern Education Society's College of Engineering, Pune -01
Dept. of Electronics and Telecommunication Engineering
IEEE Signal Processing Society
Sponsored
IETE Pune Centre Approved
7th National Conference on
Advancements in Communication, Computing and
Electronics Technology [ACCET]
[19th June 2021]

Date: 22 / 06 / 2021

Conference Report

Name of the Activity: ACCET 2021- National Conference

Date of Activity: 19 / 06 / 2021

Venue: Online on Microsoft Teams Platform.

IETE Pune Center approved and IEEE Signal Processing Society Sponsored, 7th National Conference on 'Advancements in Communication, Computing and Electronics Technology [ACCET-2021] was organized by the Department of E&TC Engineering on 19th June 2021. There has been a huge response to the call-for-papers for the Conference ACCET-2021.

Around 74 numbers of full length papers have been received from the researchers, academicians and industry persons of the leading organizations, institutes and industries, not only from Maharashtra like Nashik, Baramati, Ahmednagar, Shirpur, Karad, Jintur, Solapur, Nagpur, Akola and Pune region, but also from out-states places such as Tamilnadu, Karnataka, Bihar, Chhattisgarh, West Bengal, Andhra Pradesh, Jharkhand, Rajasthan, Haryana.

A committee of 21 reviewers put in their efforts to filter 69 good quality technical papers out of approximately 74 received ones. Total 57 Paper were presented on the day of conference. The observations and suggestions by the reviewers were helpful to the authors for further improvements in their papers. A total of 31 papers are sent for publication in IOSR-JEN.



ACCET 2021 National Conference Group Photograph

Reviewers list for ACCET 2021

Sr. No.	Reviewer Name	Institute
1.	Dr. M. P. Dale	MESCOE, Pune
2.	Dr. P. P. Mane	MESCOE, Pune
3.	Dr. K. S. Tiwari	MESCOE, Pune
4.	Dr. P. N. Kota	MESCOE, Pune
5.	Prof. S. N. Dharwadkar	MESCOE, Pune
6.	Prof. N. Masood	MESCOE, Pune
7.	Prof. Shailendra Badwaik	SCOE, Pune
8.	Dr. Rubeena Khan	MESCOE, Pune
9.	Dr. Y. H. Dandwate	VIIT, Pune
10.	Dr. R. M. Bodade	MCET, Mhow, Indore
11.	Dr. Vinayak Bairagi	AISSMS, IOIT, Pune
12.	Dr. S. K. Wagh	MESCOE, Pune
13.	Dr. Mithra	DY Patil , Pimpri
14.	Dr. Tushar Jadhav,	VIIT, Pune
15.	Dr. Vrushali G Raut,	SCOE
16.	Dr. Prachi R.	MAE , Alandi
17.	Dr. Jayshree Pansare	MESCOE Pune
18.	Dr. Varsha Harpale	PCCOE, Pune
19.	Prof. Anagha Kunte	MMCOE, Pune
20.	Dr. D. K. Shedje	AISSMS IOIT
21.	Dr. B. D. Jadhav	JSPM, Tathawade

The conference was approved by IETE Pune centre and Sponsored by IEEE Signal Processing Society Pune division. Selected Papers will be published in Scopus / UGC listed Journal and author will bear the cost of publication.

In order to motivate the participants, we have announced the 'Best Paper Award' for the papers from each category. By and large these technical papers added a true value in current research and development trends in the field of Communication, Computing and Electronics Engineering.

ACCET-2021 Schedule

June 19th, 2021 Saturday,
09:30 – 10:50 Opening Ceremony
11:00 – 12:30 Keynote Sessions
12:30 – 13:00 Lunch Break
Online Oral Presentations
13:00 – 16:00
Sessions: S1,S2,S3,S4,S5,S6,S7,S8,S9,S10,S11,S12
16:10 – 17:00 Valedictory

On the day of the conference, i.e. on Saturday 19th June 2021, the Inaugural Function was arranged in online mode on Microsoft Teams at 10 am. Prof. M. M. Dhanvijay, the conference Co-coordinator, gave the introductory speech and greeted the dignitaries and the participants. The inaugural function was hosted by Dr. K. S. Tiwari. The function was started with 'Saraswati Poojan' by playing audio tune in the presence of the dignitaries.

Dr. P. P. Mane, the conference convener, presented the key points about the conference in her welcome address.

Dr. M. P. Dale, Vice Principal highlighted the important activities of the college and gave best wishes to ACCET-2021.

Later the unveiling of the conference Souvenir was taken place facilitated by Dr. P. N. Kota. Dr. P. P. Mane, H.O.D., E & Tc. encouraged the participants with her motivating speech. Dr. A. J. Hake, Life Member, M. E. Society elaborated the significance of paper presentation and publication. Principal Dr. S. S. Sarawade mentioned the importance of the conference in his speech.

The function was also graced by the Guest of honour and the key-note speaker Dr. Ram Bilas Pachori

Professor, Department of Electrical Engineering, Indian Institute of Technology Indore. The audience were addressed by Chief Guest, Prof. Dr. D. S. Bormane, Principal, AISSMS COE, Pune and Co-coordinator, BOS, Electronics, SPPU, Pune.

The function was concluded with the vote of thanks by Dr. P. P. Mane.

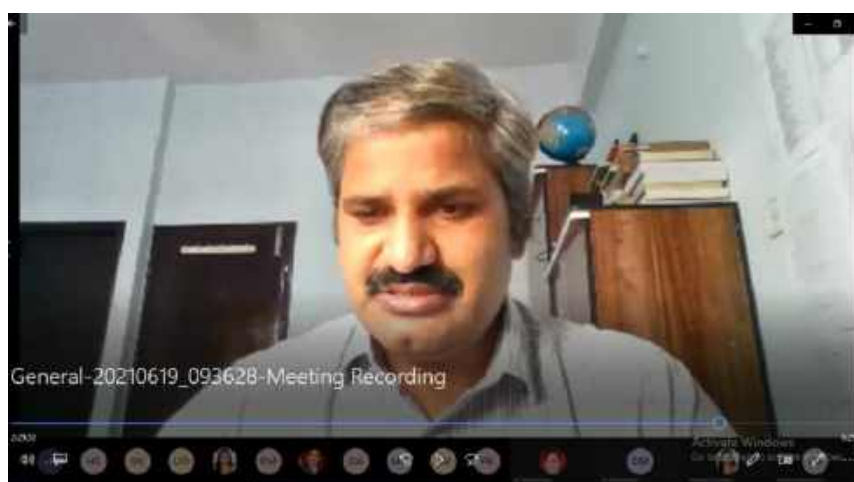

Dr. Ram Bilas Pachori while presenting keynote speech.

The key note address was given by Dr. Ram Bilas Pachori after the inaugural function on the topic Fourier-Bessel series expansion based empirical wavelet transform for non-stationary signals.

After lunch, the paper presentation sessions were started in online mode on Microsoft Teams. Twelve parallel sessions of paper presentation were conducted.

Session	Internal session chair	External session chair
S1	Dr. P. P. Mane and Prof. P.H. Mohite	Dr. D. K. Shedge
S2	Dr. K. S. Tiwari and Prof. P. S. Tondewad	Dr. B. D. Jadhav
S3	Dr. P. N. Kota	Dr. Y. H. Dandwate
S4	Prof. B. M. Narute and Prof. Pratiksha Nandanwar	Dr. Mithra
S5	Dr. M. P. Dale and Prof. N. Masood	Dr Rajesh Bodade
S6	Prof. Y. M Ajgar	Dr. Shailendra Badwaik
S7	Dr. P. B. Chopade	Dr. Prachi R.
S8	Prof. U. V. Bomble	Dr. Vrushali G Raut
S9	Prof. A. A. Dhavlikar	Dr. Vinayak Bairagi
S10	Prof. S. N. Dharwadkar	Dr. Somnath Dhonde

S11	Prof. Priyanka Bagul	Prof. Anagha Kunte
S12	Prof. S. S. Pansare and Prof. U. D. Dattasamjhe	Dr. Varsha Harpale

Best paper Awards based on technical contents and presentation skills, are given to the presenters from each session.



Dr.P.P.Mane announcing the best paper awards

ACCET-2021 Team



Prof. M. M. Dhanvijay
Coordinator
National Conference (ACCET-2021)

Dr. P. P. Mane (Head, Department of E&Tc Engg.)
Convener
National Conference (ACCET-2021)

Prepared by
Prof. S. S. Pansare
Prof. M. M. Dhanvijay

MECHANICAL ENGINEERING STUDENTS ASSOCIATION

(MESA)

PHOENIX 2K18

Technical Event

(25th to 28th Sept 2018)



Modern Education Society's
COLLEGE OF ENGINEERING, PUNE-01

About MECHANICAL ENGINEERING STUDENTS ASSOCIATION (MESA)

MESA is MESCOE Mechanical Student Association. The MESA was formed to bring about the technical development of students by organizing seminars, workshops and other activities and also to improve non-technical abilities of students by engendering good communication skills, managerial abilities, presentation skills and team work.

Objectives

- To Promote the interaction between academia and industry by organizing industrial visits, special lectures and facilitate in industrial training
- Promoting the interests of students in various technical areas pertaining to mechanical engineering
- To encourage students of the mechanical Engineering department to develop their personal skills, like event management & time management by organizing inter & inter Collegiate Events
- To bring about the technical development of students by organizing seminars, workshops and other activities.

Outcomes:

The students will be able to

- Develop their technical and non-technical competitive skill
- Develop their communication skills, managerial abilities, presentation skills and team work.
- Put forth their ideas

Role of the Faculty Coordinator:

- The faculty coordinator will be responsible for team selection.
- Faculty coordinator have all rights to terminate any non performing member in the committee.
- All purchases for event conduction must be processed through faculty coordinator.
- All events should be conducted under the guidance of respective coordinator as well as respective event coordinators.

Team Selection Policy:

- Academic result is considered for the post of President and Vice-President
- All interested students for committee members are called for interview.
- The interview is conducted by faculty coordinator, Senior faculties and President in Semester II and charge is handed over to new President and committee members
-

MESA Committee member 2018-19

President	Prathamesh Chikorde	
Vice President	Rajneesh Chaudhary	
Secretary	Aditya Joshi	
Treasurer	1. Prashant Kudale	2. Jaydeep Chaukekar
	3. Ankita mandale	
Event Head	4. Tanmay Tekawade	5. Akshay Bhosale
	6. Ameya Davhale	7. Pranay Ladkat
	8. Aditya Deo	9. Augniva Saha
	10. Ateeb Khan	11. Chinmay Sheth
	12. Kunal Gatkat	13. Sumit Pawar
Event Co-ordinator	1. Meghraj Konduskar	2. Vaibhav Kale
	3. Aniket Gawande	4. Nikhil Kurai
	5. Prasad Pangul	6. Suraj Khade
Ladies Representative(LR)	1. Vaishnavi Deshpande	2. Vishakha Pawar
MESA Co-ordinators	1. Chinmay Lokhande	2. Mayur Patil
	3. Omkar Mokashi	4. Ganesh More
	5. Gaurav Balgude	6. Komalkriti Iyengar
	7. Sahil Lambe	8. Gaurav Kataria
	9. Chandan Kolpe (Photography)	10. Himanshu Patil (Photography)
Sponsorship Heads	1. Atharv muley (H)	1. Aditya khadilkar
	2. Ninad khater	3. Vaibhav Gund
	4. Vivek Sangode	5. Neha Salunkhe
	6. Kavita Mehak	7. Rohit Sangle
Decoration Heads	1. Abhishek Dhamdhare	2. Abhijit Kapadnis
	3. Nikhil Mahajan	4. Mayur Choudhari
	5. Kavita Mekhe	6. Varun Yeole
Documentation Heads	1. Sahil Tiple	2. Gagan Lokhande
	3. Shrutika Panchal	4. Aniket Gaikwad

Staff Committee Members of PHOENIX-2k18

Sr. No.	Event	Staff In-charge	Judges for Event	Students In-charge
1.	Lathe War	Prof. A. A. Chougule	1. Prof. H. S. Salave 2. Mr. S. R. Raut 3. Mr. V. A. Patil	Mr. Chinmay sheth
2.	CAD War	Prof. R. N. Yerrawar	1. Prof. S. J. Chikhale 2. Prof. N. N. Kumbhar 3. Prof. B. R. Pujari	Mr. Tanmay Tekawade
3.	GOOGLER	Prof. S. P. Gadewar	1. Dr. S. H. Gawande 2. Prof. V. J. Sonawane 3. Prof. A.A. Patil	Mr. Kunal Gadkat
4.	HOOKUP	Prof. B. D. Nandre	1. Prof. H. S. Salave 2. Prof. V. Suryawanshi 3. Prof. C. B. Meshram	Mr. Pranay Ladkat Mr. Atteb Khan
5.	POSTER PRESENTATION	Dr. S. S. Sarawade	1. Prof. V. J. Sonawane 2. Prof. K. A. Mahajan 3. Prof. P. S. Pandure	Mr. Sumit Pawar
6.	TECH QUIZ	Prof. S. R. Kandharkar	1. Dr. V. N. Chougule 2. Dr. A. C. Mitra 3. Prof. S. P. Patil	Mr. Augniva Saha
7.	TREASURER HUNT	Prof. V. M. Suryawanshi	1. Prof. V. R. Varude 2. Prof. V. S. Mane 3. Prof. P. R Magdum	Mr. Aditya Deo
8.	COUNTER STRIKE (1.6)	Prof. N. N. Kumbhar	1. Prof. A.A. Patil 1. Prof. S. J. Chikhale 2. Prof. B. R. Pujari	Mr. Ameya Davhale
2.	PUBG	Prof. S. D. Wankhede	1. Prof. V. R. Varude 2. Prof. Suhas. Jadhav 2. Prof. P. B. Birardar	Mr. Atharv Muley
3.	BOX CRICKET	Prof. K. A. Mahajan	1. Prof. Prasad Bhoge 2. Prof. S. R. Kandharkar 3. Prof. S. D. Wankhede	Mr. Akshay Bhosale

Scheduled of PHOENIX-2k18

Day & Date	Event Name	Time	Location
25 Sept 2018, Tuesday	Inauguration Ceremony	9:00 am to 9:30 am	Mechanical Workshop
	Lathe War	10:00 am to 2:00 pm	Mechanical Workshop
	Hookup	10:00 am to 2:00 pm	Mechanical Workshop
	Googler	11.45 am to 4:00 pm	Room No 107
	CAD War	11.45 am to 4:00 pm	Room No 106
	PUBG	1:00 pm to 4:00 pm	Seminar Floor (001), Ground Floor
26 Sept 2018, Wednesday	Poster Presentation	9:00 am to 11.30am	Drawing Hall 117
	Tech Quiz	9:00 am to 11.30am	Class Room 309 & 312
	Counter Strike	9:00 am to 2 pm	Room No 106 & 107
	Treasurer Hunt	2:00 pm to 3:30 pm	Ground, First & Third Floor & MESCOE Parking
27 Sept 2018, Thursday	Box Cricket	9 am to 3 pm	MESCOE Parking
28 Sept 2017, Friday	“Prize Distribution Ceremony and Group Photo	10:00 am to 1:00 pm	Seminar Hall 509

About “PHOENIX-2k18”

“PHOENIX” is regular activity organising by MESA every year to nurture the overall development of students. Phoenix-2K18 organising various technical events during 25-28th September 2018 such as Lathe War, CAD War, Googler, Hookup, Poster Presentation, Techno Quiz, Techno Treasure Hunt, Counter Strike 1.6, PUBG, Box Cricket etc. the Registration and campaigning for the events is started on the 13th September 2018. Entire MESA was in full gusto, trying their best to attract students to participate for all the events. As Phoenix-2K18 is an inter-college event, everyone is geared up to attract more students and establish themselves as excellent publicity and marketing organisers. Organising Team: - Dr. S. H. Gawande, Prof. H. S. Salave and MESA team members. Following events were scheduled on 25th to 28th Sept- 2018

Registration and Inauguration

PHOENIX-2k18 is inaugurated on the first day of event 25th September 2018 at 10:00 am in Department of Mechanical Engineering workshop by the auspicious hand of Prof. Dr. A.A. Keste (Principal) in the presence of Dr. V. N. Raibhole (Vice-Principal), Dr. V. N. Chougule (HoD, Mechanical), Dr. S. H. Gawande (MESA, Faculty Advisor), Prof. H. S. Salave (MESA, Faculty Advisor) and all the teaching and non-teaching staff. Prof. H. S. Salave delivered a brief introduction about the event PHOENIX-2k18.



Registration Desk of PHOENIX-2k17



Inaugurated by Dr. A. A. Keste (Principal), Dr. V. N. Raibhole (Vice- Principal) and Dr. V. Chougule (HoD)



MESA Team

LATHE WAR

The Lathe war event work started from Friday 23rd SEPT with the cutting of NYLON material used in competition. According to design material was cut in given length in all 34 pieces were cut. All participants were given all rules through text messages. There were 3 batches performing in event. Invitation to judges were sent day before event. All of this was done before event got started

Nylon Material for Lathe War:



Cutting Material

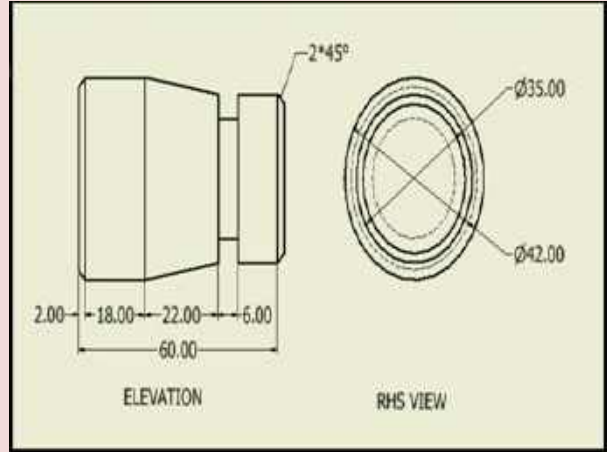

Job Design

Event Winner and Runner-up:

Winner	Shivam Shinde & Aarti Bhagat
Runner-up	Mohit Gaikwad & Shubham Bendale

Proof:



CAD WAR

The event work started from Saturday, 22nd Sept with the check of PC's in the lab with the help of coordinators and under the guidance of Prof. R. N. Yerrawar. Subsequently the questions to be 3D modeled by the participants were also selected. 2 Questions were selected for the event. On 24th SEPT the sponsorer's banner was also put up on the outside wall of the lab under the guidance of Prof. R. N. Yerrawar & Prof. H. S. Salave & the participants were contacted to convey the timings & venue of the event

Event Winner and Runner-up:

Winner	Rohan Koshti (TE MECH 2)
Runner-up	Shriram Batav (TE MECH 1)

Proof:



HOOK UP

The event work started from Saturday, 22nd Sept with the selection of Assemblies and respective tools required in the workshop with the help of coordinators and under the guidance of Prof. B. D. Nandre. Subsequently the Assemblies to be assembled and disassembled by the participants were also checked. 4 Assemblies were selected for the event. On 24th SEPT the Event Posters was also put up on the outside wall of the workshop under the guidance of Prof. B. D. Nandre & the participants were contacted to convey the timings & venue of the event.

Event Winner and Runner-up:

Winner	Sahil Tikkal & Yash Chatur
Runner-up	Tanmay Thorat & Atharva Tungikar.

Proof:



TECH QUIZ

The event work started from Saturday. 22nd Sept with the getting the permission for getting the access for room no. 309 and 312 .After getting the permission the team started the work of decoration by making a poster to guide the participants towards the room in which the event was to be conducted

On 26th The first round was rapid fire round in which 21 teams participated out of which 8 teams qualified for 2nd round.

Second round was an audio visual round in which each team was asked 5 questions .Accordingly only 4 teams were qualified for the 3rd and final round .here the teams were provided with 10 questions each which were mcq based .4 points were given to the correct answer and -1 for the wrong one . after the event was wrapped up the EVENT WINNERS were declared by us & reported

Winner	Aniket Sharma & Akash Rohan
Runner-up	Taiyyab Shaikh

Proofs:



POSTER PRESENTATION

The event work started on Tuesday 25th Sept with the decoration of Drawing Hall 117. All participants were given reminder calls along with detail explanation of rules. There were 11 groups performing in event. Invitation to judges were sent day before event.

On the day of event a small inauguration was conducted in drawing hall 117 at 10 am. After Inauguration the event along with the presence of Event Head, Event Coordinators & other MESA members officially began.

Event Winner and Runner-up:

Winner	Uma Mirji & Shubham Medankar
Runner-up	Tanaya Biswas & Stephanie

Proof:



TECHNO TREASURE HUNT

The event work started on Tuesday 25th Sept with the decoration of Drawing Hall 117. All participants were given reminder calls along with detail explanation of rules. There were 11 groups performing in event. Invitation to judges were sent day before event.

On the day of event a small inauguration was conducted in drawing hall 117 at 10 am. After Inauguration the event along with the presence of Event Head, Event Coordinators & other MESA members officially began.

Event Winner and Runner-up:

Winner	Jyoti Kalokhe, Prajakta Saste and Piyush Muthal
--------	---

Proof:



GOOGLER

The event work started from Saturday 22nd Sept with the check of PC's in the lab with the help of coordinators and under the guidance of Prof. S.P.Gadewar. On 24th Sept, the participants were contacted to convey the timings & venue of the event.

The EVENT'S 1st round was conducted at 12:00 pm with all the participants seated at their respective allotted PC's & the questions being handed over to them. The time allotted for each participant was 2:30 minutes to answer the questions(5 questions each with 1mark)&6 minutes were given to prepare documentation on given topic. The participants comprised of the classes from SE, TE & BE Mechanical divisions. The participants used their fast typing skills to answer the question and prepare the documentation in the allotted time. At 1 pm the 1st round of the event was concluded. Then the top 8 participants with most correct answers were selected for round 2.

The selected participants were given 10:00 minutes time to prepare for their presentation. Then the 2nd round begins at 2:00 pm. The participants were made to give presentation in front of our judges on the documentation they prepared in round 1 and then finally the event concluded at 3:30 pm. The participants were guided during their entirety of the event for problems regarding the conduct of the event. After the completion of the 2nd round, we officially declared that the EVENT was finished & was successfully completed. The EVENT took place completely in accordance to the instructions of Prof. S.P. Gadewar & Prof. H. S. Salave.

Event Winner and Runner-up:

Winner	Jalaj Shukla
Runner-up	Gurusha Lulla

Proof:



COUNTER STRIKE

The event work started from 25th Sept with the check of PC's in the lab with the help of coordinators and under the guidance of Prof. N. N. Kumbhar. The participants were contacted to convey the timings & venue of the event. at 9 am the event was inaugurated by Prof. H. S. Salave, Prof. N. N. Kumbhar along with the presence of MESA Committee Members, Event Coordinators & other MESA members by cutting the ribbon

The EVENT'S 1st round was conducted at 9:15 am with all the participants seated at their respective allotted PC's. The game version used was C.S-1.6. The teams comprised of the classes from FE, SE, TE & BE. The participants used their gaming skills to play and to win the tournament. At 2 pm the 1st round of the event was concluded.

The 2nd round started the next day i.e. on 27th Sept. The matches were held accordingly and the winner team was concluded. The teams were guided during the entire event for problems regarding the conduct of the event. After the completion of the 2nd round, we officially declared that the EVENT was finished & was successfully completed. The EVENT took place completely in accordance to the instructions of Prof. N. N. Kumbhar

Event Winner and Runner-up:

Winner	Shreyas Shetty and team
--------	-------------------------

Proof:



BOX CRICKET

The event was scheduled on 27th September 2018. In the morning, by 8am, all the preparations for the event were done and the preparation for the inauguration started. By the same time all the participant teams started reporting. The inauguration was done by Professor K.A.Mahajan, the staff incharge, at 9:30. Before that all the preparations were ensured by the team.

The event finally started immediately after the inauguration. The matches were conducted successfully without any disputes. All my coordinators helped me in coordination. All the BE students helped in umpiring and controlling the crowd.

The semi finals started near around 5pm after eliminating all the teams and the final was conducted simultaneously. Overall, the event was a great success!

Event Winner and Runner-up:

Winner	Team Aditya.
Runner-up	Team Abhyuday.

Proof:



Engineers Day Celebration and Prize Distribution Ceremony:

“PHOENIX” is regular activity organized by MESA of Department of Mechanical Engineering of M.E.S. College of Engineering Pune every year to nurture the overall development of students. Under PHOENIX-2K18 various technical and non-technical events are scheduled during 25-28th September 2018 such as Lathe War, CAD War, Googler, Hookup, Poster Presentation, Techno Quiz, Techno Treasure Hunt, Counter Strike 1.6, PUBG, Box Cricket etc. **PHOENIX-2k18** was inaugurated on the first day of event 25th September 2018 at 10:00 am in Department of Mechanical Engineering workshop by the auspicious hand of Prof. Dr. A.A. Keste (Principal) in the presence of Dr. V. N. Raibhole (Vice-Principal), Dr. V. N. Chougule (HoD, Mechanical), Dr. S. H. Gawande (MESA, Faculty Advisor), Prof. H. S. Salave (MESA, Faculty Advisor) and all the teaching and non-teaching staff. Prof. H. S. Salave delivered a brief introduction about the event PHOENIX-2k18. The conclusion of **PHOENIX-2k18** was scheduled on 28th September 2018 with distribution of prizes and certificates to winning and runner teams. More than 300 students from various colleges affiliated to Savitribai Phule Pune University were participated.



Welcome Speech by Prof. H. S. Salave



Prize Distribution by Dr. A. A. Keste (Principal) and Dr. V. N Chougule (HoD)



Prize Distribution by Dr. S. S. Sarwade and Dr. A. C. Mitra



Prize Distribution by Dr. S. H. Gawande and Prof. H. S. Salave



Organizing Committee of PHOENIX-2k18



MESA Team with Dr. A. A. Keste (Principal) & Dr. V. N. Chougule (HoD)

“PHOENIX-2k18” Event Article Published in Sakal Times

Publicity Article (Published on 22/09/2018)

Sakal Times

Tech buzz

If you are a tech geek, then Phoenix-2K18 is where you should shine. The inter-collegiate competition, Phoenix-2K18, organised by the Mechanical Engineering Students Association (MESA) of MES College of Engineering, starts from September 25.

The MESA was formed to bring about the technical development of mechanical engineering students by organising technical events, lectures, seminars, workshops by experts, besides co-curricular and extra-curricular activities.

The four day competition, Phoenix-2K18, includes various technical events like Lathe War, CAD War, Googlet, Hookup, Poster Presentation, Techno Quiz, Techno Treasure Hunt, Counter Strike 1.6, PUBG, Box Cricket etc. The registration and campaigning for the events began on September 13. To register, contact 9021088007/8888897509.



STPUNE Supplement
22092018 Page No. 4

MESCOE organises Phoenix-2k18 in city



BEGINNING: The Principal of MESCOE Prof Dr AA Keste (C) inaugurates 'Phoenix-2k18' at the Mechanical Engineering Dept.

ST CORRESPONDENT
reporters@sakaaltimes.com

Pune: Phoenix-2k18, an activity by the Department of Mechanical Engineering of MES College of Engineering (MESCOE), was inaugurated on Tuesday.

Principal Prof Dr AA Keste inaugurated the event in the presence of Vice-President Dr VN Raibhole, Head of Department (Mechanical) Dr VN Chougule, Dr SH Gawande, Prof HS Salave and all the teaching and non-teaching staff.

Prof HS Salave delivered a brief introduction about the event Phoenix-2k18.

Under Phoenix-2k18, various technical and non-tech-

Principal Prof Dr AA Keste inaugurated the event in the presence of Vice-President Dr VN Raibhole, Head of Department (Mechanical) Dr VN Chougule, Dr SH Gawande, Prof HS Salave and all teaching and non-teaching staff.

nical events are scheduled from September 25 to 28, which include Lathe War, CAD War, Googler, Hookup, Poster Presentation, Techno Quiz, Techno Treasure Hunt, Counter-Strike 1.6, PUBG, Box Cricket, etc.

STPUNE, Main
26/09/2018 Page No. 4

Sakal Times

MES CoE organises 'Phoenix'



BEAMING:
Participants of Phoenix-18 at the MES College of Engineering.

ST CORRESPONDENT

reporters@sakaaltimes.com

Pune: For the overall development of students, the annual activity of MESA of Department of Mechanical Engineering of MES College of Engineering, Pune recently organised an event.

Under the PHOENIX-2K18, various techni-

cal and non-technical events were held such as Lathe War, CAD War, Googler, Hookup, Poster Presentation, Techno Quiz, Techno Treasure Hunt, Counter Strike 1.6, PUBG, Box Cricket etc.

It was inaugurated in Department of Mechanical Engineering workshop by AA Keste (Principal) in the presence of VN Raibhole

(Vice-Principal), VN Chougule (HoD, Mechanical), SH Gawande (MESA, Faculty Advisor), HS Salave (MESA, Faculty Advisor) and all teaching and non-teaching staff.

Salave gave a brief introduction about the event. More than 300 students from various colleges affiliated to Savitribai Phule Pune University participated.

STPUNE, Main
20/10/2018 Page No. 6

Vision of Department

To groom Motivated, Environmental friendly, Self-esteemed, Creative and Oriented Mechanical Engineers

Mission of Department:

To Develop Industry Oriented Manpower to accept the challenges of Globalization by,

- Imparting mechanical engineering knowledge through trained faculty in conducive environment,
- Creating awareness about the needs of mechanical industries through alumni and industry-institute interactions
- Encouraging them to think innovatively and introduce them to various research activities
- Supporting them to groom in all aspects like communication, interpersonal skills.

Program Educational Objectives:

The following Program Educational Objectives are established for the Mechanical Engineering:

- **Pre-preparation:** To prepare students with strong foundation in mathematical, scientific and engineering fundamentals that will enable them to have successful career in Core Mechanical and Interdisciplinary Industries.
- **Core Competence:** To prepare students for rapid technological change with core Mechanical Engineering domain knowledge.
- **Breadth:** To enable students to develop their knowledge and skills across the range of disciplines.
- **Professionalism:** To prepare students for soft skills with good communication, ethical values and ability to work in a team
- **Learning Environment:** To prepare students to strengthen their knowledge and skills through self-learning abilities throughout their professional career as well as to pursue higher education.

Mechanical Engineering Program Outcomes:

The Mechanical Engineering graduates will be able to:

1. **Engineering knowledge:** Apply the knowledge of mathematics, science, engineering fundamentals, and an engineering specialization to the solution of complex engineering problems.
2. **Problem analysis:** Identify, formulate, review research literature, and analyze complex engineering problems reaching substantiated conclusions using first principles of mathematics, natural sciences, and engineering sciences.
3. **Design/development of solutions:** Design solutions for complex engineering problems and design system components or processes that meet the specified needs with appropriate consideration for the public health and safety, and the cultural, societal, and environmental considerations.
4. **Conduct investigations of complex problems:** Use research-based knowledge and research methods including design of experiments, analysis and interpretation of data, and synthesis of the information to provide valid conclusions.
5. **Modern tool usage:** Create, select, and apply appropriate techniques, resources, and modern engineering and IT tools including prediction and modeling to complex engineering activities with an understanding of the limitations.
6. **The engineer and society:** Apply reasoning informed by the contextual knowledge to assess societal, health, safety, legal and cultural issues and the consequent responsibilities relevant to the professional engineering practice.

7. **Environment and sustainability:** Understand the impact of the professional engineering solutions in societal and environmental contexts, and demonstrate the knowledge of, and need for sustainable development.
8. **Ethics:** Apply ethical principles and commit to professional ethics and responsibilities and norms of the engineering practice.
9. Individual and team work: Function effectively as an individual, and as a member or leader in diverse teams, and in multidisciplinary settings.
10. **Communication:** Communicate effectively on complex engineering activities with the engineering community and with society at large, such as, being able to comprehend and write effective reports and design documentation, make effective presentations, and give and receive clear instructions.
11. **Project management and finance:** Demonstrate knowledge and understanding of the engineering and management principles and apply these to one's own work, as a member and leader in a team, to manage projects and in multidisciplinary environments.
12. **Life-long learning:** Recognize the need for, and have the preparation and ability to engage in independent and life-long learning in the broadest context of technological change.
13. **PSO I:** Apply principles of machine design, manufacturing, thermal engineering and management to identify, formulate and solve real life problems in various fields of engineering
14. **PSO II:** Use modern modeling, simulation techniques and computational tools.
15. **PSO III:** Develop practical solutions for mechanical engineering problems/processes under professional and ethical constraints.

Modern Education Society's
College of Engineering, Pune.



Department of E&TC and Mechanical Engineering
e-BAJA SAEINDIA-2020



TEAM GYRFALCONS

SAE BAJA

BAJA SAEINDIA is an Inter-collegiate design competition organized by SAE. Teams of students from colleges all over the country design and build 'Electric ALL TERRAIN VEHICLES'. The goal is to design, manufacture and race ATV's that can withstand the harsh elements of rough terrain.

The competition has Dynamic as Static events: -

- The Dynamic events include a 4 Hour endurance race, Maneuverability and acceleration tests.
- Whereas the static events include Design, Sales and Marketing and Cost Presentations. A tally of all these events decides the overall winner of the event.

TEAM GYRFALCONS

1. **BAJA 2019:** Secured 3rd place in virtual presentation round. Completed all Static and Dynamic Events successfully. **Lightest vehicle amongst all teams. Overall Ranked 9th out of 60 participants.**
2. **BAJA 2020:** 2nd in virtual presentation. Failure in clearing the Technical Inspection due to damaged electrical components. **We had the Lightest vehicle amongst all teams and the team Secured an overall 9th rank amongst 80 participants. We were also the Winner of Sales presentation and Design presentation awards.**



BAJA 2020

TEAM FORMATION

- For formation of the BAJA 2020 team, the selection process begun from March 2019.
- The students interested to work with the team were enrolled and the motive and purpose of BAJA was explained to them.
- **Stage 1** : The students then had to undergo a test based on their technical knowledge and basic understanding about the advancements in automobile industry.
- **Stage 2** : The presentation skills and technical knowledge of the students was tested by assigning them a topic of their interest. The candidates were expected to prepare a Powerpoint presentation regarding the assigned topic and explain about the same to a panel consisting of seniors and alumni's of the team.
- **Stage 3** : Each candidate was interviewed by an interview panel which consisted of faculty advisors as well as senior members of the team.
- A team of 25 students was created. It consisted of students from SE, TE and BE.
- **Mr. Aditya Jagtap** and **Mr. Ameya Khedkar** were selected as the Team Captain and Vice-Captain respectively after an interview conducted by the faculty advisor, **Prof. Balkrishna Pujari** and **Prof. Priyanka Tondewad**.
- 6 departments viz **Roll cage, Suspension, Steering, Transmission, Electricals** and **Brakes** were formed and the recruits were allotted a department of their choice.



TEAM REGISTRATION

- In all there were 80 openings for the Indore event for which teams registered from all over the country. The virtual round was held at Chitkara university, Chandigarh, Punjab.
- A team of 5 students was selected to deliver the presentation in the virtual round.
- The presentation included advancements in the new vehicle and changes to be made. A slide containing all the **lessons the team learnt** and the mistakes made was also included in the presentation.

- The team prioritized weight reduction and improvised handling for year 2020. We also optimized each component the vehicle and iterations were made as per requirement.
- Changes were made till an optimum design was achieved. This design offered a balance of competitive performance with strong impact withstanding ability as the driver safety was of prime importance.
- The suspension department opted for an entirely new design geometry and 50-50 weight distribution.
- The transmission department used a new **Timing belt and pulley** model. This ensured a better acceleration time and less driver fatigue.
- **AISI 4130** was selected as the optimum material for building the chassis of the vehicle as it had enough strength and durability. A Gantt chart was prepared which gave us a timeline for the work to be completed.

BAJA VIRTUAL RESULT

- The results of the VIRTUAL round were announced within a week. **Team Gyrfalcons representing Modern Education Society's College of Engineering ranked 2nd among 80 teams** that were selected for the Indore Event. The next step was the team registration for the second phase.

MANUFACTURING STAGE

- The newly recruited team members were allotted departments **like grooving, welding, drilling, housekeeping, documentation and panelling.**
- The procurement of **Primary, secondary and tertiary pipes** was done.
- **Special off-road tyres and rims were procured** which had a low mass and overall lighter weight. A custom-made steering rack was ordered which would enable our buggy to manoeuvre within the tightest corners.
- For assembling the chassis, a fresh fixture table was prepared which gave us the required **precision and accuracy.**
- Pipes were fixed into the each other by precise grooving and then welded together to make a rigid frame.
- Members of suspension department like **H-Arms** and **Wishbones** were also prepared using fixtures.



MACHINING

- **Knuckles, hubs, gears, tie-rods, wishbones, gearbox casing, steering wheel, steering column, steering arms, brake disc, shafts** etc. were machined both in-house and by some vendors.
- Machining is a very vital process as it requires accuracy and errors cannot be negotiated. Some parts were delayed and the schedule of the team was disturbed, but we did a good job by not lagging behind time.
- The machined components like shafts, gears, hubs, discs and other supporting components were hardened by heat treatment process to improve their life.



BAJA SAEINDIA 2020

- The event was scheduled from **23th to 25th January 2020**.
- The event was held at **Pithampur, Indore (M.P.)**. The team arrived in Indore on 21st January 2020 and was accompanied by faculty advisors.
- **Team GYRFALCONS** finished BAJA SAEINDIA 2020 by ranking **Overall 9th out of 80** participating teams. The team had its moments of glory by winning 2 awards at the event. As a result of the efforts taken by our Designing and Sales team, **the team won the Design Presentation and the Sales and Marketing Presentation awards**. In spite of our rigorous testing we failed at clearing the Technical Inspection due to some damaged components during transportation. It was a great year and we had a strong performance with all the changes we made. The Team strives to take up the challenges faced by the upcoming event and has aimed for the number one spot at BAJA 2021.
- Despite all the problems we faced, we bounced back with a strong resolve to perform.

Learning from our ups & downs, we are determined to compete in BAJA 2021 with an even stronger performing and optimised vehicle.



BUDGET

Sr. No.	Content	Amount
1	College Share	2,39,115
2	Student Contribution	1,43,000
3	Sponsorship	67,100
	Total	4,49,215

ACHIEVEMENTS

- Overall 2nd in Virtual event.
- 1st in Sales Presentation.
- 1st in Design Presentation.
- Overall 9th in main event.



FINAL STAGE



Faculty Advisor

HoD Mechanical

HoD E&TC

Registrar

Principal



SUCCESS JOURNEY OF
MESCOE'S BAJA VEHICLE
CAR NO. 62
BAJA SAE INDIA
NATRAX, PITHAMPUR, INDORE

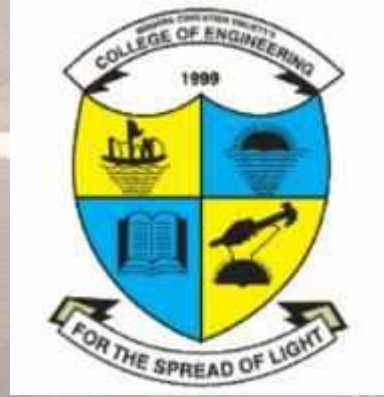

TEAM GYRFALCONS

...SURVIVE TO SUCCEED



THE DESIGN PHASE

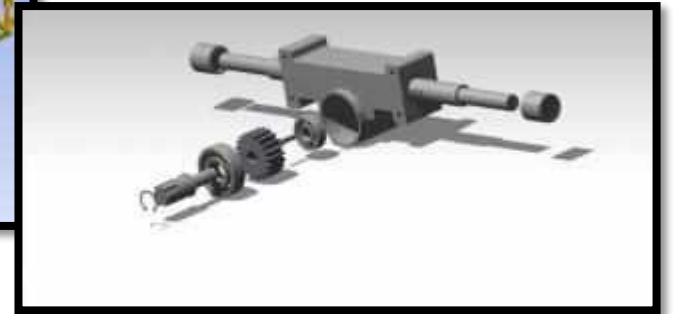
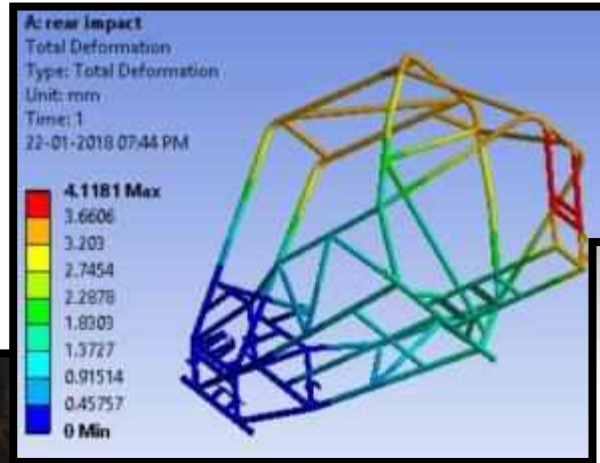
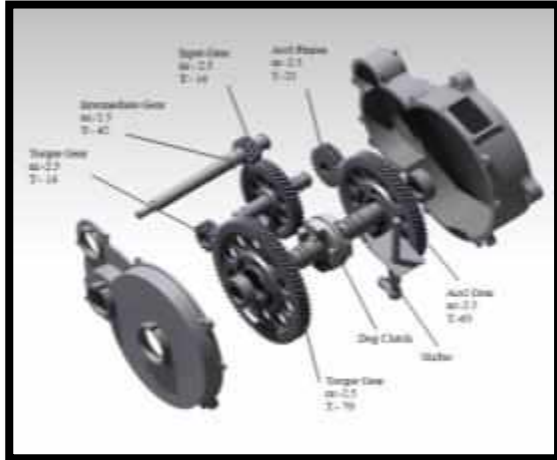



RANKED 51 OUT OF 378 TEAMS AT CHITKARA UNIVERSITY, CHANDIGARH (14TH JULY 2016)





THE MANUFACTURING PHASE





RIGOROUS TESTING OF 25 DAYS





ACHIEVEMENTS



- Runner up in **SALES PRESENTATION** with a total score of 48.6 out of 50 points. (*missed the award by 0.1 point*)
- 9th position off 120 teams in **ENDURANCE RACE** with a total score of 320 out of 400 points.
- Successfully completed **SUSPENSION** and **SLED PULL** track.



COMPLETING 21ST (LAST) LAP WITHOUT ANY FAILURE



Pic Courtesy: www.drivespark.com





CHASING THIS YEARS CHAMPIONS IN THE ENDURANCE RACE



FEATURED IN CARTOQ NEWS BLOG



THE WINNING SHOT



APPEARED IN CARTOQ NEWS BLOG



Key To Our Success ...
MODERN EDUCATION SOCIETY'S COLLEGE
OF ENGINEERING

OUR SPONSORS





VICTORY MOMENT WITH TEAM





TRIBUTE TO OUR NATION ON REPUBLIC DAY





Photo published in Mahindra Autocar's Supplement





MR. RUSHIKESH GHOGARE
(CAPTAIN)
(HEAD:SUSPENSION DEPT)
(CAE DEPT)



MR. GAURAV LABHADE
(VICE CAPTAIN)
(HEAD: TRANSMISSION DEPT)
(PRIMARY WELDER)



MISS RAKHEE VERMA
(HEAD:STEERING DEPT)
(SPONSERSHIP DEPT)



MISS MOHINI DAHALE
(HEAD: BRAKES DEPT)
(SPONSERSHIP DEPT)

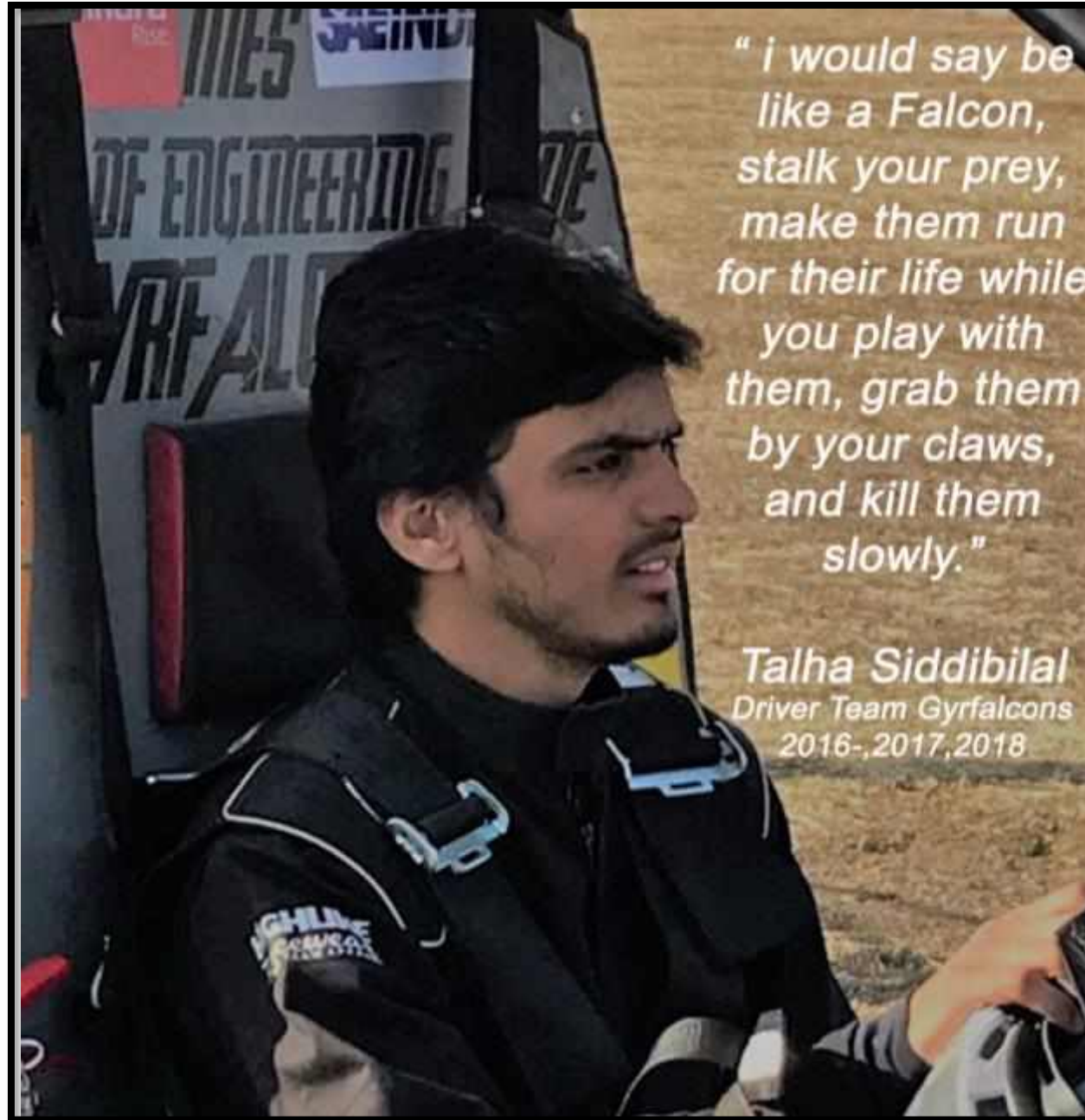

" i would say be like a Falcon, stalk your prey, make them run for their life while you play with them, grab them by your claws, and kill them slowly."

*Talha Siddibilal
Driver Team Gyrfalcons
2016-,2017,2018*

MR.TALHA SIDDIBILAL
(DRIVER)
(TRANSMISSION DEPT)



MR.RISHIKESH PAWAR
(SECOND-DRIVER)
(TRANSMISSION DEPT)



MR. SHUBHAM BENDALE
(SUSPENSION DEPT)
(QUALITY MANAGER)



MR. ANIKET SURYAWANSHI
(TRANSMISSION DEPT)
(CAE DEPT)



MR.ABHIMAN SHINDE
(BRAKES DEPT)



MR.MANOJ MANDAVKAR
(STEERING DEPT)



MR.MOHIT GAIKWAD
(SUSPENSION DEPT)
(CAD ASSEMBLY)



MR.MAYURESH DEO
(SUSPENSION DEPT)



MR.SHIVAM SHINDE
(ROLLCAGE DESIGN)
(CAE DEPT)



MR.ADITYA JAGTAP
(BRAKES DEPT)
(ELECTRIC DEPT)



MR.ANVITH SHETTY
(TRANSMISSION DEPT)



MR.SHUBHAM JAIN
(BRAKES DEPT)
(MATERIAL SPONSER)



MR.PRAVIN SHIROLE
(STEERING DEPT)



MR.KARAN BEDMUTHA
(STEERING DEPT)



The Dream Begins With The Teachers Who Believe In Us...



**PROF. S.R KANDHARKAR
(FACULTY ADVISOR)**



**PROF. V.R VARUDE
(FACULTY ADVISOR)**



**BE A PART OF THIS
INCREDIBLE FAMILY FOR
BAJA SAE INDIA 2019 & GET
YOURSELF NOTED IN MESCOE'S
MOST PRESTIGIOUS TEAM**

Modern Education Society's College of Engineering, Pune-01

2.3.2. Teachers use ICT enabled tools for effective teaching-learning process

S. No.	Content	Page No.
1.	Innovations in Teaching-Learning	2
2.	NPTEL Facility	3
3.	MESCOE Faculty YouTube Channel	5-6
4.	e-Resources on Teams, Google Classroom	6

MS TEAMS FOR TEACHING-LEARNING

- Due to Pandemic, Traditional teaching is completely replaced by digital teaching.
- Staff members are using MS teams online platform for instruction delivery.

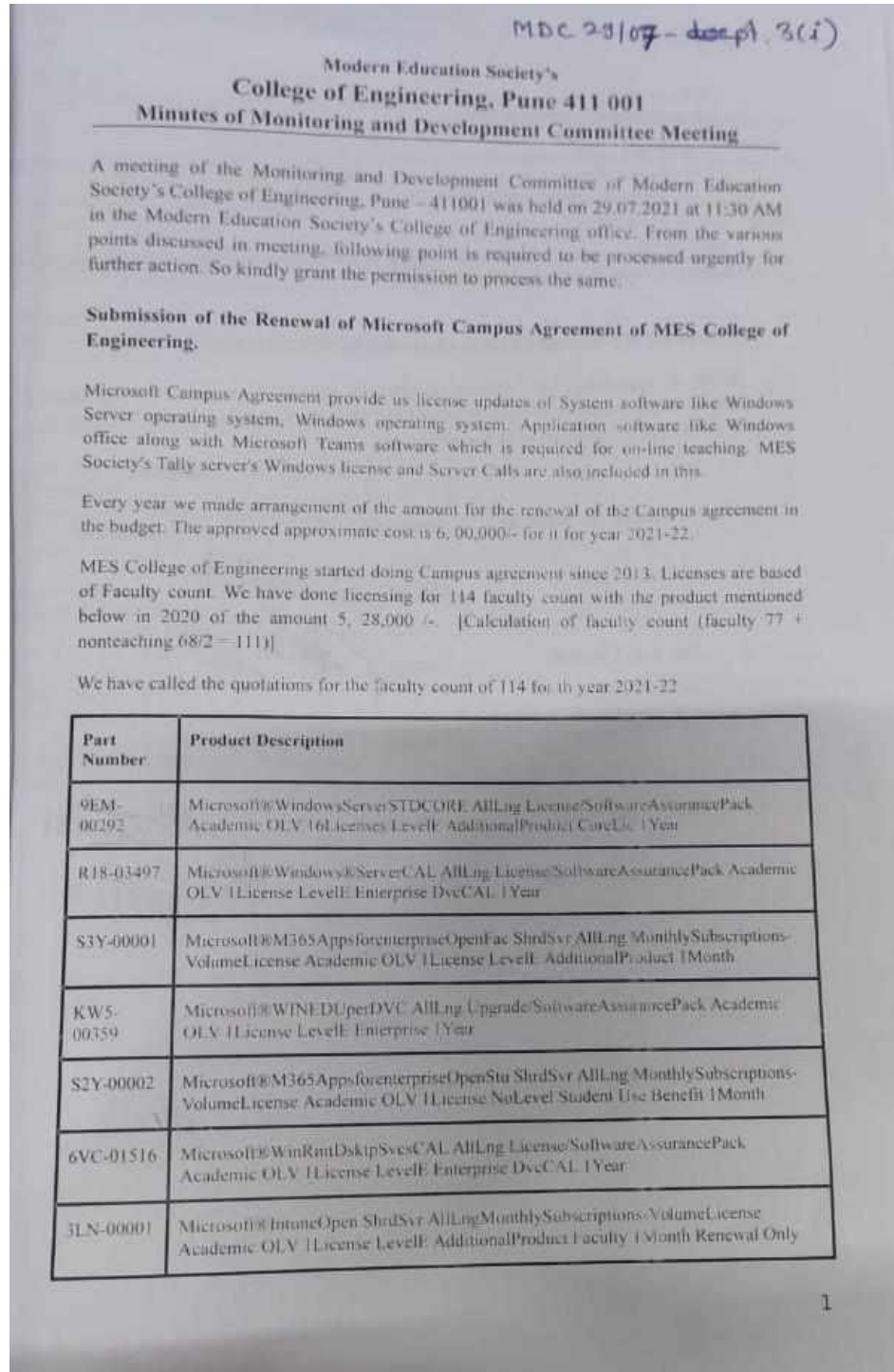

NPTEL FACILITY and CENTER OF EXCELLENCE

- The institute has bought several NPTEL vidoes and the evidences can be observed on college website:

<http://mescoepune.org/library-facilities.php>

- The institute also has Smart Digitally enabled classroom.



Digital Classroom



Computer Centre



NI Lab

MESCOE's Blogspot

The respective faculty of every department is active on their departmental blogspot and the data is also shared to students through this medium.

The link for institute blogspot is <http://mescoe.blogspot.com/p/te-e.html>

MESCOE
Modern Education Society's College of Engineering, Wadia Campus, Pune - 411001.

HOME | COMP | E & TC | MECII | CONTACT

Vision
To Create - Motivated, Environment friendly, self-oriented, Creative and Oriented Engineers.

Mission
To Develop Industry Oriented Manpower to accept the challenges of Globalization, by promoting Value Education through motivated trained faculty, by maintaining conducive environment for

An online data sharing portal for the students of **MESCOE**; where faculty can share their **assignments/notes** with students just on a single window.

Faculty - To avail this facility you need to follow a single one time procedure. [Click here](#).

Students - To access the study material just click on the name of the faculty from respective departments.

E & TC
Department of E & TC Engineering

NPTEL
NPT - Video Tutorials



YouTube Channel of Faculty:

Prof. Y. M. Ajar of E&TC department and Dr. Aparna Prayag of First year department has created her YouTube channel for disseminations of information to students.



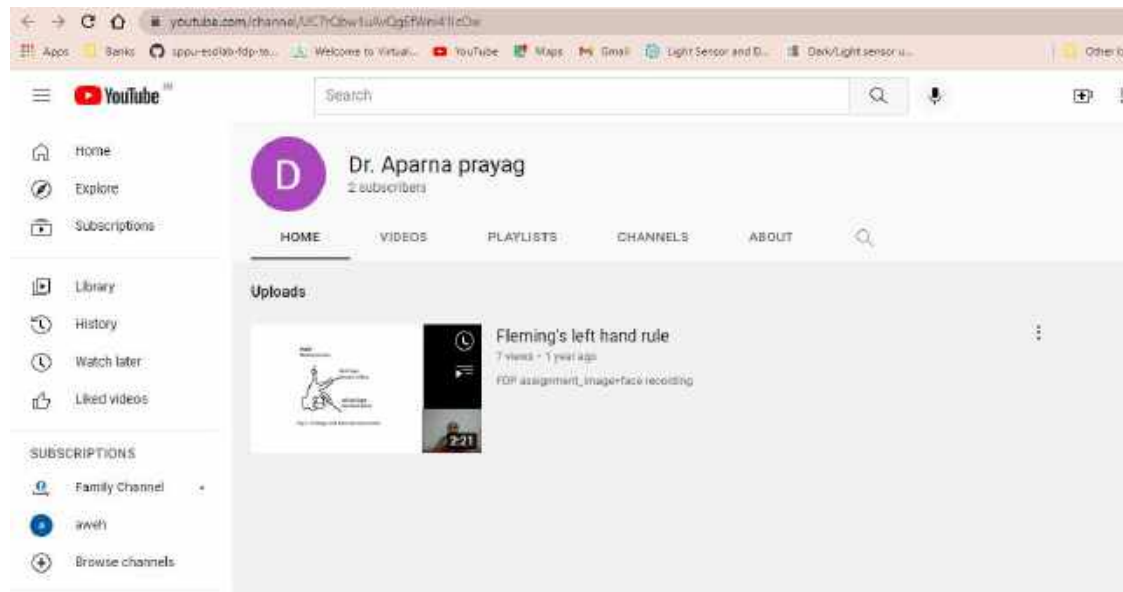

Since its regular practice (due to pandemic) at department to do instruction delivery using Teams platform Faculty also upload teaching material, lab handouts on Teams repository.

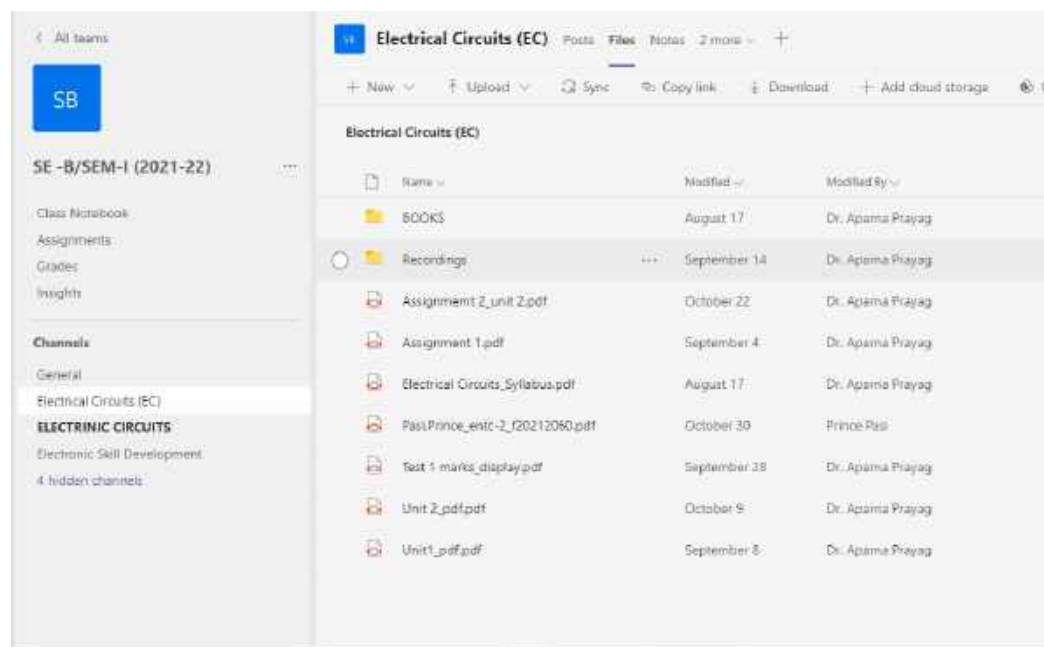

M.E.S. College of Engineering, Pune. 411001.

Teaching and Learning: Experiential Learning, Participative Learning and Problem solving methodology

Sr. No.	Content	Head	Dept
01	Industrial visit BSNL RTTC	Experiential Learning	E&TC
02	Industrial visit Baker	Experiential Learning	Mech
03	Internship BSNL	Experiential Learning	E&TC
04	Webinar on Internship	Experiential Learning	Mech
05	ETSA	Experiential Learning	E&TC
06	Guest Lecture	Experiential Learning	Comp
07	Guest Lecture Research trends	Experiential Learning	E&TC
08	Guest Lecture	Experiential Learning	Mech
09	Project	Participative learning	comp
10	Latex workshop	Participative learning	Mech
11	Linux workshop	Participative learning	E &TC
12	IOT Entrepreneurship workshop	Participative learning	E & TC
13	Jhankar	Participative learning	MESCOE
14	ACCET	Participative learning	E & TC
15	shodh	Participative learning	MESCOE
16	MESA	Participative learning	MECH
17	EBAJA	Problem solving methodology	E &TC
18	MBAJA	Problem solving methodology	MECH